

Decra Elegance Tile

England, Ireland & Welsh Practice

Comments:

Drawing no	Description	Shown In Decra Brochure	Most Commonly Used Detail
DESE001	Tile Components - <i>Selection of angles</i>		
DESE002	Section Components - <i>Standard Components Using B Type Ridge</i> - <i>Standard Components Using D Type Ridge</i>		
DESE003	Tile Elevation components - <i>Elevations at a selection of angles</i>		
DESE004	Standard section through tiles - <i>Typical section through tiles</i>		<input checked="" type="checkbox"/>
DESE013	Eaves detail using eave guard 400 unventilated and 600mm rafter spacing - <i>Eaves detail greater than 15 ° pitch</i> - <i>Eaves detail 10 ° to 15 °</i>		<input checked="" type="checkbox"/>
DESE014	Eaves detail using eave guard 400, unventilated and 900/1200mm rafter spacing - <i>Eaves detail greater than 17.5 ° roof pitch</i> - <i>Eaves detail greater than 15 ° to 17.5 °</i> - <i>Eaves detail 10 ° to 15 °</i>		<input checked="" type="checkbox"/>
DESE015	Eaves detail using eave guard 400 10mm eaves vent and 600mm rafter spacing - <i>Eaves detail greater than 15 ° roof pitch</i> - <i>Eaves detail 15 °</i>		<input checked="" type="checkbox"/>
DESE016	Eaves detail using eave guard 400, 10mm eaves vent and 900mm / 1200mm rafter spacing - <i>Eaves detail greater than 17.5 ° roof pitch</i> - <i>Eaves detail 15 ° to 17.5 °</i>		<input checked="" type="checkbox"/>
DESE017	Eaves detail using eave guard 400, 25mm eaves vent and 600mm rafter spacing - <i>Eaves detail greater than 15 ° roof pitch</i> - <i>Eaves detail 10 °</i>		<input checked="" type="checkbox"/>
DESE018	Eaves detail using eave guard 400, 25mm eaves vent and 900mm/1200mm rafter spacing - <i>Eaves detail greater than 17.5 ° roof pitch</i> - <i>Eaves detail greater than 15 ° to 17.5 °</i> - <i>Eaves detail 10 ° to 15 °</i>		<input checked="" type="checkbox"/>
DESE019	Warm roof eaves detail using Decra warm roof eave guard and eave closure and Decra mesh - <i>Warm roof eaves detail</i>		<input checked="" type="checkbox"/>
DESE020	Unventilated 'D' Ridge Detail - <i>'D' ridge detail</i> - <i>'D' ridge detail</i>	<input checked="" type="checkbox"/>	<input checked="" type="checkbox"/>
DESE021	Ventilated 'D' Ridge detail using Universal D Ridge Ventilator - <i>Vented 'D' ridge detail</i>	<input checked="" type="checkbox"/>	<input checked="" type="checkbox"/>
DESE022	Ventilated 'D' Ridge detail using Decra D Ridge Vent Filler Unit - <i>Vented 'D' ridge detail</i>	<input checked="" type="checkbox"/>	<input checked="" type="checkbox"/>
DESE023	B' ridge details - <i>'B' ridge detail</i> - <i>'B' ridge detail</i>		
DESE027	D Ridge Gas Flue Terminal Tile - Ridge detail - Flue component isometric	<input checked="" type="checkbox"/>	<input checked="" type="checkbox"/>
DESE030	Hip Detail using B Type Ridge - Hip detail using Decra 'B' ridge - Cutaway isometric to hip		
DESE031	Hip details using D Type Ridge - Hip detail using Decra 'D' ridge - Cutaway isometric to hip	<input checked="" type="checkbox"/>	<input checked="" type="checkbox"/>
DESE032	Ventilated Hip Detail using D Type Ridge - Hip detail using Decra 'D' ridge - Cutaway isometric to hip	<input checked="" type="checkbox"/>	<input checked="" type="checkbox"/>
DESE040	Mono Ridge Detail (D Type Ridge) - Mono ridge detail	<input checked="" type="checkbox"/>	<input checked="" type="checkbox"/>
DESE041	Mono Ridge Details D Ridge with D Ridge / Hip Vent - <i>Mono ridge detail</i>	<input checked="" type="checkbox"/>	<input checked="" type="checkbox"/>
DESE042	Mono Ridge Details D Ridge using D Ridge Vent Filler - Mono ridge detail		<input checked="" type="checkbox"/>

DESE044	Mono Ridge Details B Type Ridge - <i>Mono ridge detail</i> - <i>Alternative mono ridge detail</i>		
DESE049	Cloaked verge cap detail - <i>Barge with cloaked verge cap detail</i> - <i>Isometric at gutter</i>		<input checked="" type="checkbox"/>
DESE051	Vertical Tiling Detail - <i>Vertical tiles detail</i> - <i>Vertical tiles isometric detail</i>		
DESE053	Raking Verge - Internal Gutter - <i>Raking verge detail</i> - <i>Raking verge detail</i>		
DESE054	Raking Verge Detail - <i>Raking verge detail</i>		<input checked="" type="checkbox"/>
DESE055	Valley gutter details - <i>Lead valley detail using layboards</i> - <i>Lead valley detail using layboards over rafters</i> - <i>GRP valley detail</i>		<input checked="" type="checkbox"/>
DESE056	Valley gutter details to felted / boarded roof - <i>Lead valley detail on felt or boarded roof</i> - <i>Lead valley detail using 50 x 50mm tile battens</i>		<input checked="" type="checkbox"/>
DESE060	Mansard Roof Details - <i>Mansard using lead flashing</i> - <i>Mansard using top course</i>	<input checked="" type="checkbox"/>	<input checked="" type="checkbox"/>
DESE061	Flashing details to chimney - <i>Flashing details to chimney</i>		<input checked="" type="checkbox"/>
DESE062	Soil vent terminal details - <i>Soil vent pipe through roof</i> - <i>Inline tile ventilator to soil vent pipe</i>		<input checked="" type="checkbox"/>
DESE064	Vertical Corner Details - <i>Detail of external corner using Decra 'B' ridge</i> - <i>Detail of external corner using Decra 'D' ridge</i>		
DESE065	Detail at change in roof pitch using Decra eave guard 400 and 25mm ventilator - <i>Detail at change in pitch</i> - <i>Detail in change in pitch</i>		<input checked="" type="checkbox"/>
DESE070	Abutment detail with secret gutter - <i>Abutment detail with secret gutter</i>		<input checked="" type="checkbox"/>
DESE071	Abutment details - <i>Abutment detail without outside flashing</i>		<input checked="" type="checkbox"/>
DESE072	Roof Sheeting Abutment Details - <i>Detail of Decra abutting asbestos / profiled sheet</i> - <i>Detail of Decra abutting asbestos / profiled sheet</i>		
DESE073	Slate and Tile Abutment Details - <i>Detail of Decra abutting concrete tiles of profiled section</i> - <i>Detail of Decra abutting slate or flat profile concrete tile</i>		
DESE080	Velux rooflight EDH flashing - <i>Typical section</i> - <i>Typical cross-sections</i>		<input checked="" type="checkbox"/>

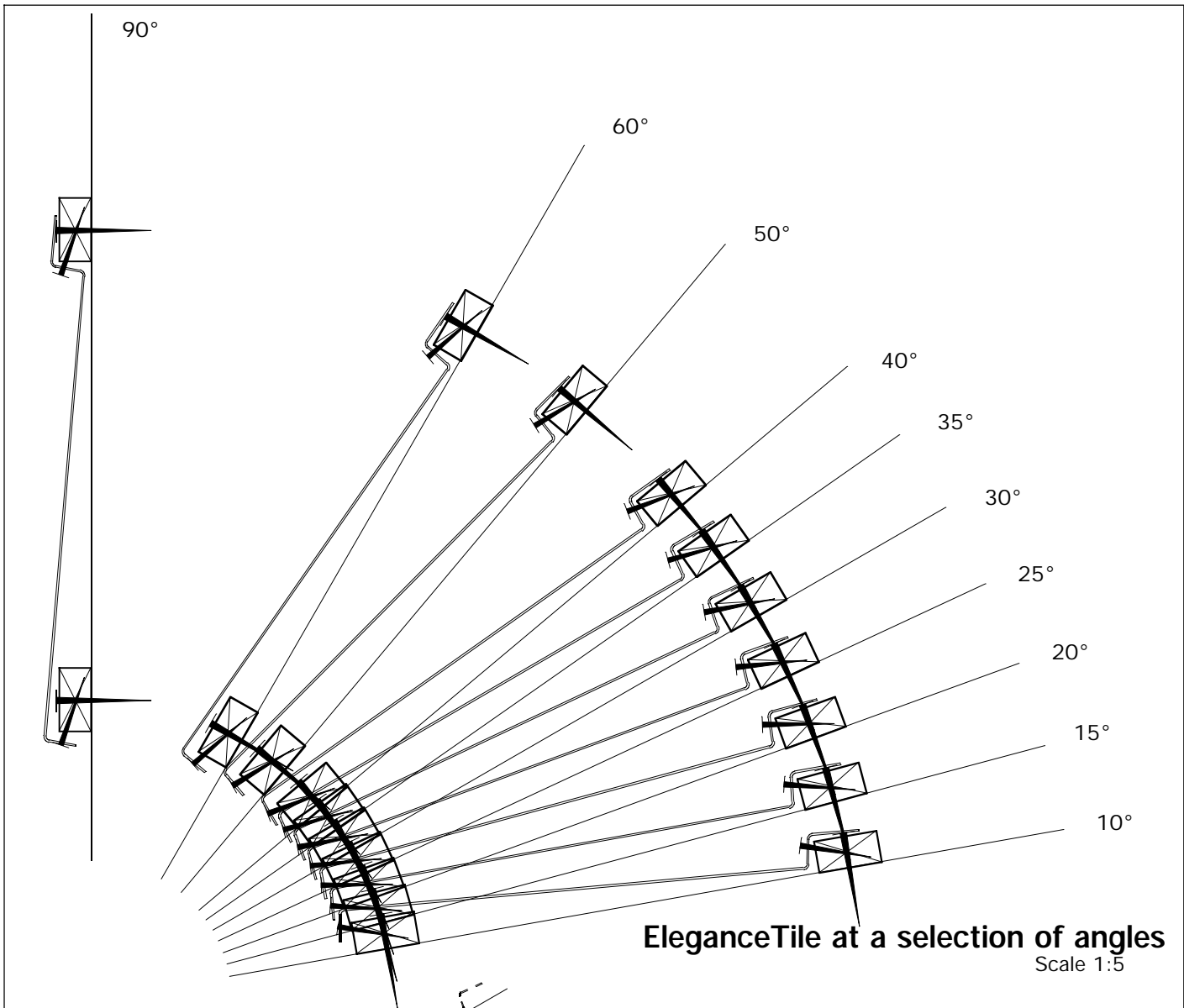

EleganceTile at a selection of angles
Scale 1:5

Duplicate a tile and batten. Move them 370mm along the line of the counter batten as shown to increase the number of rows of tiles on the roof.

Rotate the line of tiles, battens, counter battens and sarking as required and adjust the fascia and ridge cap to suit the desired pitch of roof.

These components can be scaled for use on larger or smaller scale detail drawings.

Notes:

Refer also to the Detail drawings when using these components.

Decra[®]
Roof Systems Limited

A member of the Icopal Group



Unit 4
Crompton Fields
Crompton Way
Crawley
West Sussex
RH10 9QB

telephone: (01293) 545058/9

fax: (01293) 562709

email: technical@decra.co.uk

web-Site: <http://www.decra.co.uk>

The copyright of this drawing and detail information belongs to Decra Roof Systems Limited. Reproduction or amendment outwith the terms of the licensing agreement by other parties is expressly forbidden.

DECRA ELEGANCE

CONTENT

**DECRA ELEGANCE
TILE COMPONENTS**

DRAWING SCALE

1:5

DATE

07/09/98

DRAWING NO

DESE001

REVISION

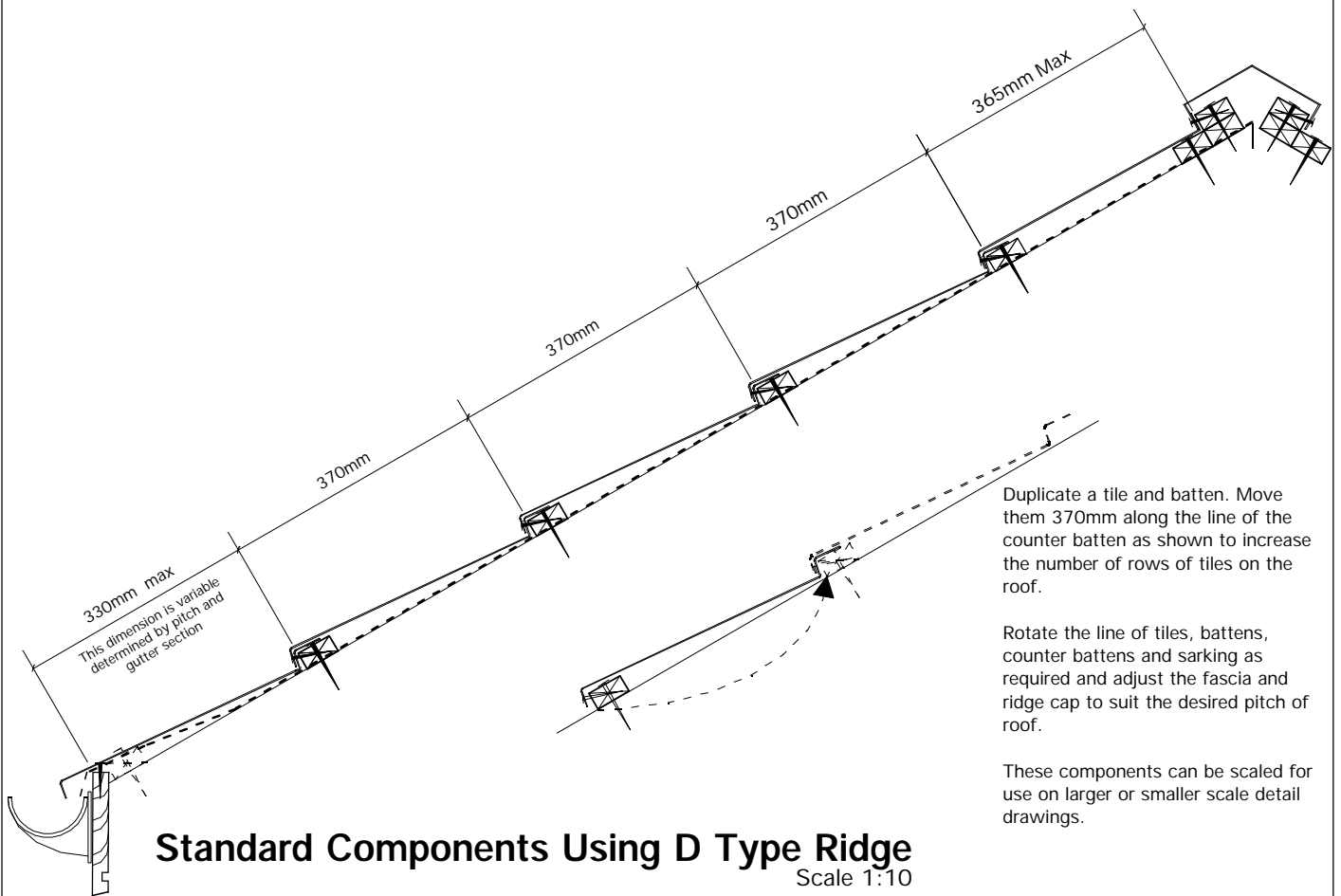

Standard Components Using D Type Ridge
Scale 1:10

Duplicate a tile and batten. Move them 370mm along the line of the counter batten as shown to increase the number of rows of tiles on the roof.

Rotate the line of tiles, battens, counter battens and sarking as required and adjust the fascia and ridge cap to suit the desired pitch of roof.

These components can be scaled for use on larger or smaller scale detail drawings.

Notes:

Refer also to the Detail drawings when using these components.
For Ventilated situations copy the relevant eaves and D ridge details from the Detail drawings.

Decra[®]
Roof Systems Limited
A member of the Icopal Group



Unit 4
Crompton Fields
Crompton Way
Crawley
West Sussex
RH10 9QB

telephone: (01293) 545058/9
fax: (01293) 562709
email: technical@decra.co.uk
web-Site: <http://www.decra.co.uk>

The copyright of this drawing and detail information belongs to Decra Roof Systems Limited. Reproduction or amendment outwith the terms of the licensing agreement by other parties is expressly forbidden.

DECRA PANTILE

CONTENT	DECRA ELEGANCE SECTION COMPONENTS	
DRAWING SCALE	1:10	DATE 07/09/98
DRAWING NO	DESE002	REVISION

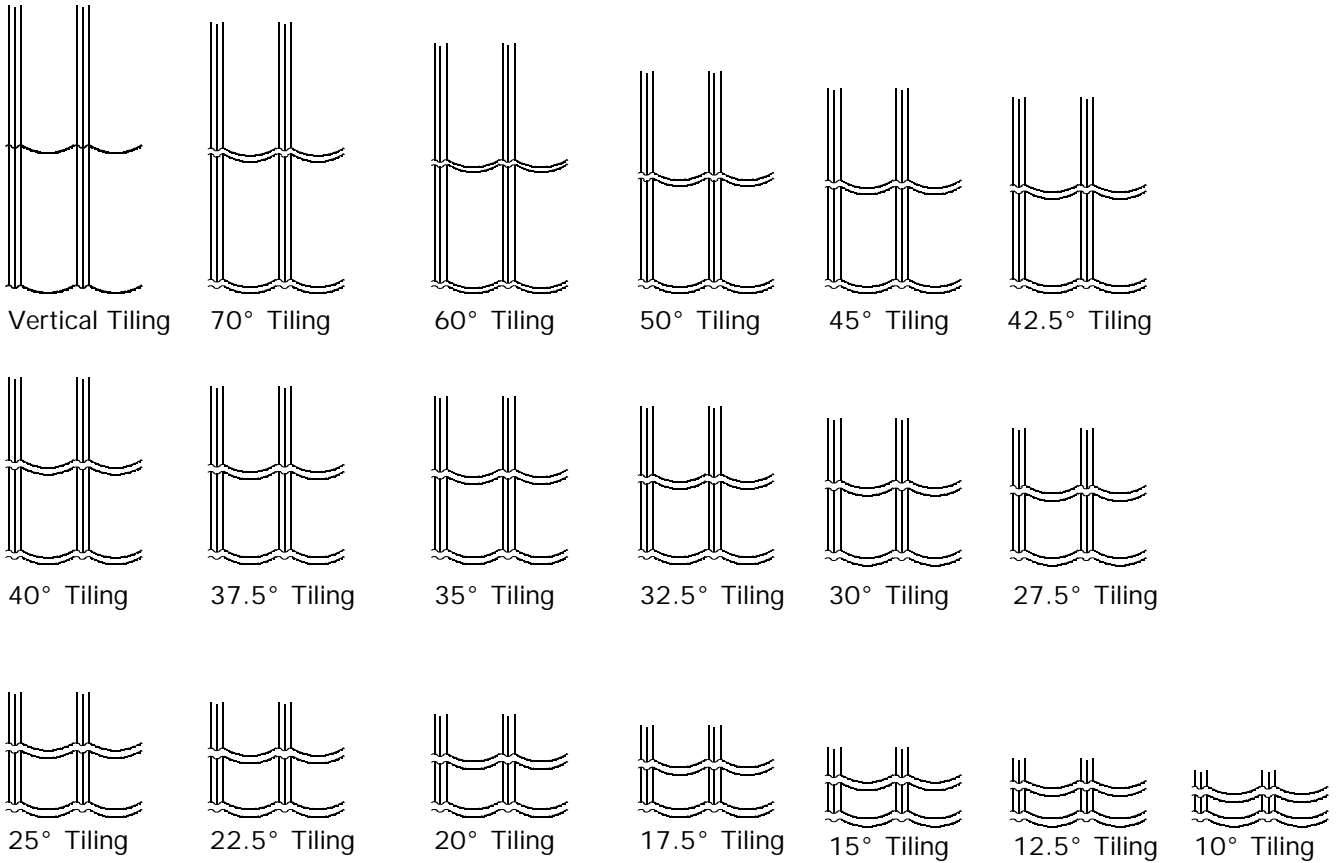

Elegance tile elevations at a selection of angles

Scale 1:20

To use the elevations:

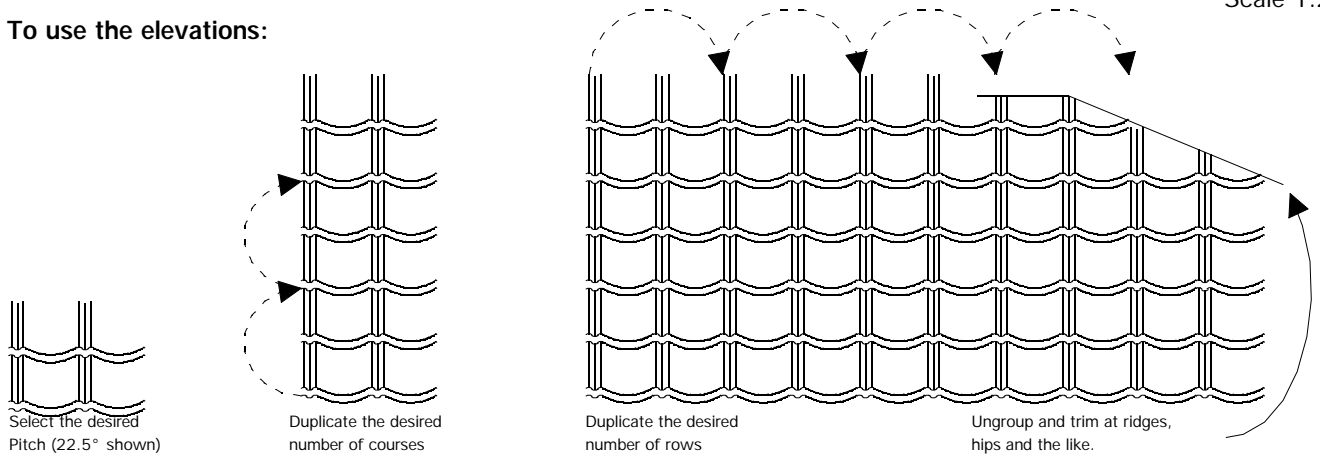

Notes:

The elevation components are given to assist in the production of elevations and are intended to give an indication of the appearance of the Decra tiles at the various pitches noted. To use the components select the one closest to the pitch of your roof and duplicate as shown. If a more accurate indication is required you should construct your own using the profile given in the component drawing for the Decra tile and rearrange it using construction lines from a Elegance roof drawn at the desired pitch.

Decra[®]
Roof Systems Limited

A member of the Icopal Group



Unit 4
Crompton Fields
Crompton Way
Crawley
West Sussex
RH10 9QB

telephone: (01293) 545058/9
fax: (01293) 562709
email: technical@decra.co.uk
web-Site: <http://www.decra.co.uk>

The copyright of this drawing and detail information belongs to Decra Roof Systems Limited. Reproduction or amendment outwith the terms of the licensing agreement by other parties is expressly forbidden.

DECRA ELEGANCE

CONTENT

**DECRA ELEGANCE
TILE ELEVATION COMPONENTS**

DRAWING SCALE **1:20**

DATE **07/09/98**

DRAWING NO **DESE003**

REVISION

Tile Batten (minimum thickness 25mm) @ 370mm spacings. Size is determined by rafter spacing, refer to table in technical information brochure.

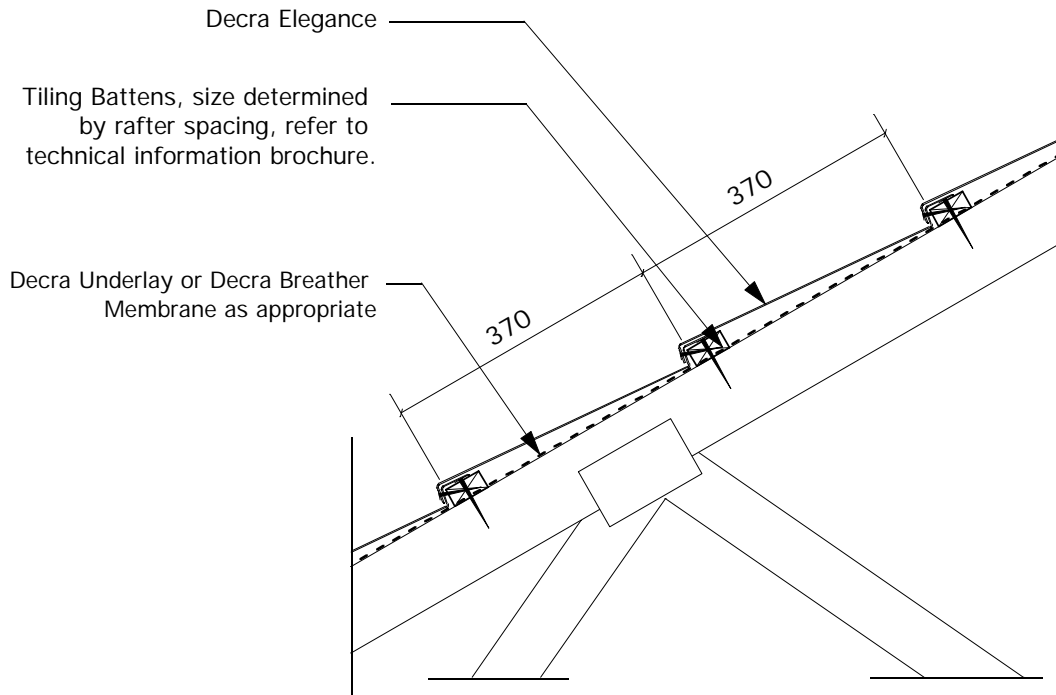

Typical Section through Tiles
Scale 1:10

Notes:

Decra[®]
Roof Systems Limited
A member of the Icopal Group



Unit 4
Crompton Fields
Crompton Way
Crawley
West Sussex
RH10 9QB

telephone: (01293) 545058/9
fax: (01293) 562709
email: technical@decra.co.uk
web-Site: <http://www.decra.co.uk>

The copyright of this drawing and detail information belongs to Decra Roof Systems Limited. Reproduction or amendment outwith the terms of the licensing agreement by other parties is expressly forbidden.

DECRA ELEGANCE

CONTENT		
DECRA ELEGANCE TILE STANDARD SECTION THROUGH TILES		
DRAWING SCALE	1:10	DATE 07/09/98
DRAWING NO	DESE004	REVISION

Battens illustrated 50x25mm for rafter/truss spacing of 600mm

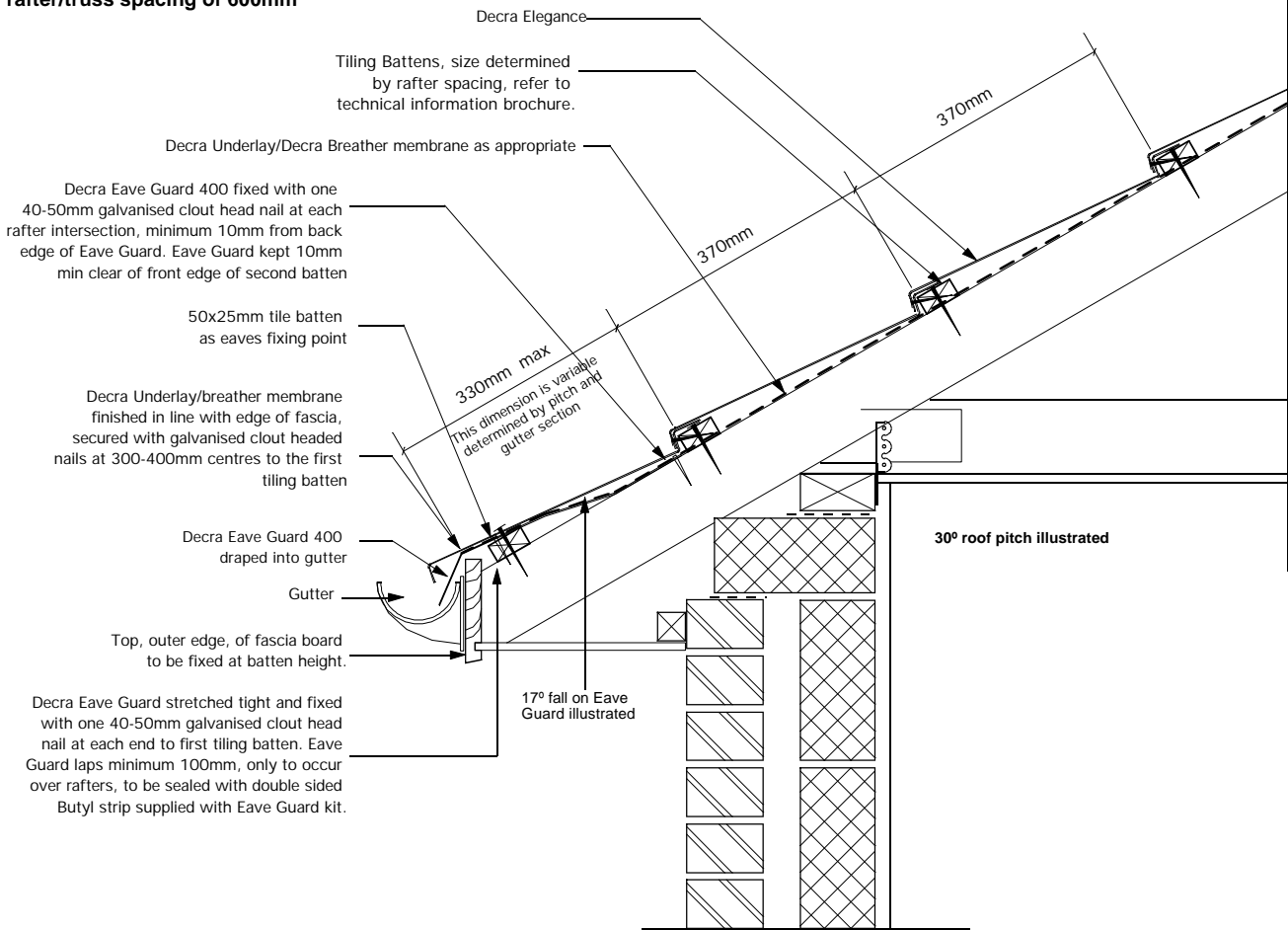

At low roof pitches care must be taken when setting out the underlying roof structure that ponding does not occur.

Eaves Detail greater than 15° roof pitch

Scale 1:10

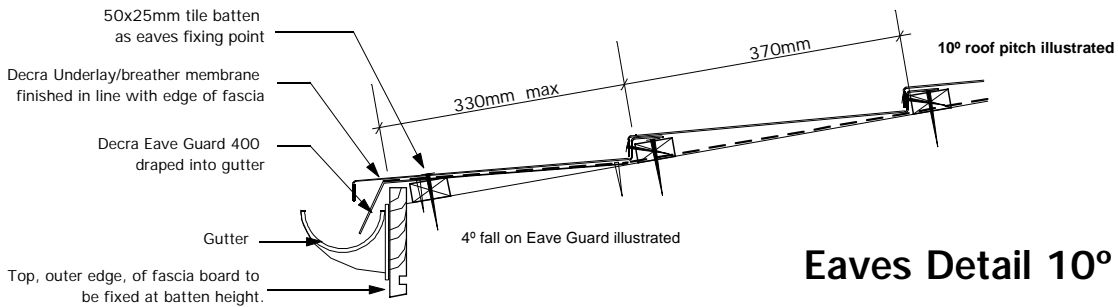

Eaves Detail 10° to 15°

Scale 1:10

Note: fixing notes on top detail for Eave Guard and edge of underlay apply to this detail also

Notes:

This detail drawing is to be read in conjunction with the Decra Eave Guard 400 installation instructions.

This eaves arrangement can be used where soffit ventilation (not shown on this drawing) is being used.

Decra Eaves Guard has a front and back edge. It is essential that it is installed the right way round with the front edge draped into the gutter and the textured edge on top.

On eaves course of tile, the tiles are fixed vertically through the high point of the tile into the batten directly behind the fascia with Decra Nails. The nail heads to be covered with a finishing kit (supplied by Decra).



Decra[®]
Roof Systems Limited

A member of the Icopal Group



Unit 4
Crompton Fields
Crompton Way
Crawley
West Sussex
RH10 9QB

telephone: (01293) 545058/9

fax: (01293) 562709

email: technical@decra.co.uk

web-Site: <http://www.decra.co.uk>

DECRA ELEGANCE

CONTENT

EAVES DETAIL

USING EAVE GUARD 400

UNVENTILATED AND 600MM RAFTER SPACING

DRAWING SCALE

1:10

DATE

15/04/03

DRAWING NO

DESE013

REVISION

The copyright of this drawing and detail information belongs to Decra Roof Systems Limited. Reproduction or amendment outwith the terms of the licensing agreement by other parties is expressly forbidden.

Battens illustrated 50x50mm for rafter/truss spacing of 900 & 1200mm

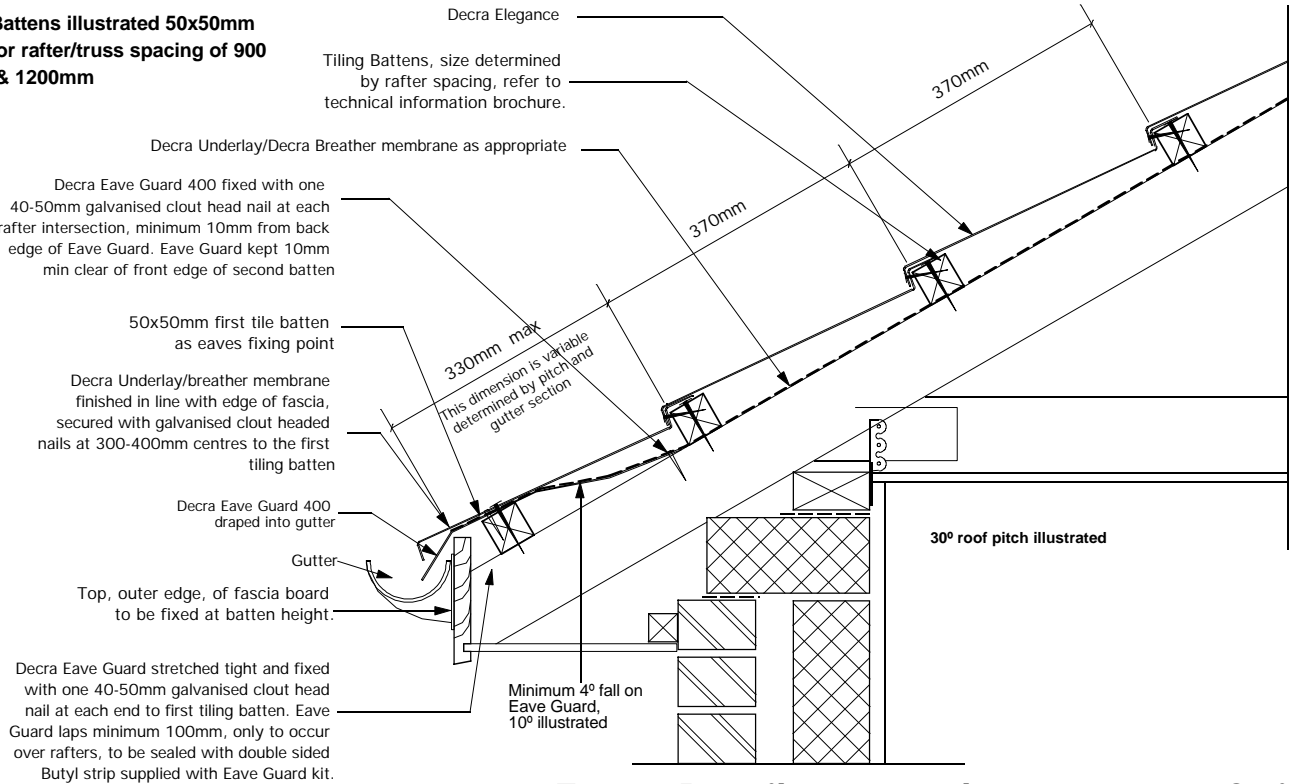

Eaves Detail greater than 17.5° roof pitch

Scale 1:10

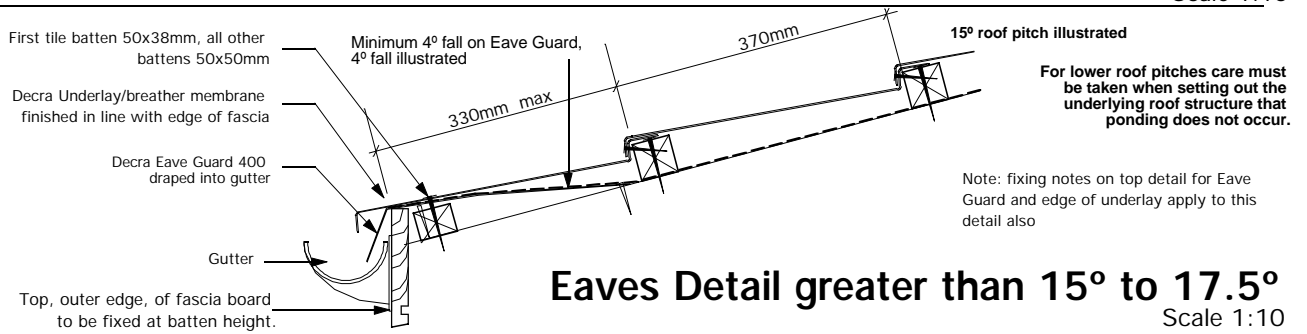

Eaves Detail greater than 15° to 17.5°

Scale 1:10

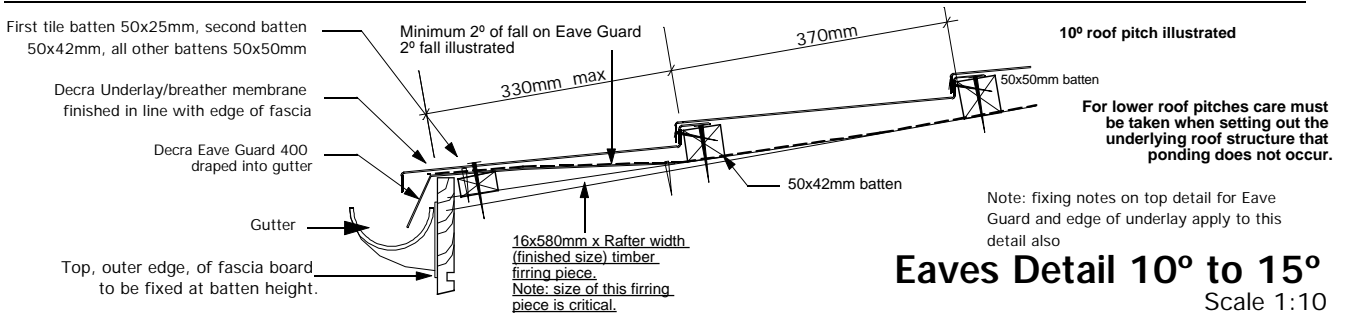

Eaves Detail 10° to 15°

Scale 1:10

Notes:

This detail drawing is to be read in conjunction with the Decra Eave Gaurd 400 installation instructions.

This eaves arrangement can be used where soffit ventilation (not shown on this drawing) is being used.

Decra Eaves Gaurd has a front and back edge. It is essential that it is installed the right way round with the front edge draped into the gutter and the textured edge on top.

On eaves course of tile, the tiles are fixed vertically through the high point of the tile into the batten directly behind the fascia with Decra Nails. The nail heads to be covered with a finishing kit (supplied by Decra).



Decra®
Roof Systems Limited

A member of the Icopal Group



Unit 4
Crompton Fields
Crompton Way
Crawley
West Sussex
RH10 9QB

telephone: (01293) 545058/9

fax: (01293) 562709

email: technical@decra.co.uk

web-Site: <http://www.decra.co.uk>

DECRA ELEGANCE

CONTENT

EAVES DETAIL

USING EAVE GUARD 400, UNVENTILATED AND 900MM/1200MM RAFTER SPACING

DRAWING SCALE

1:10

DATE

15/04/03

DRAWING NO

DESE014

REVISION

The copyright of this drawing and detail information belongs to Decra Roof Systems Limited. Reproduction or amendment outwith the terms of the licensing agreement by other parties is expressly forbidden.

Battens illustrated 50x25mm for rafter/truss spacing of 600mm

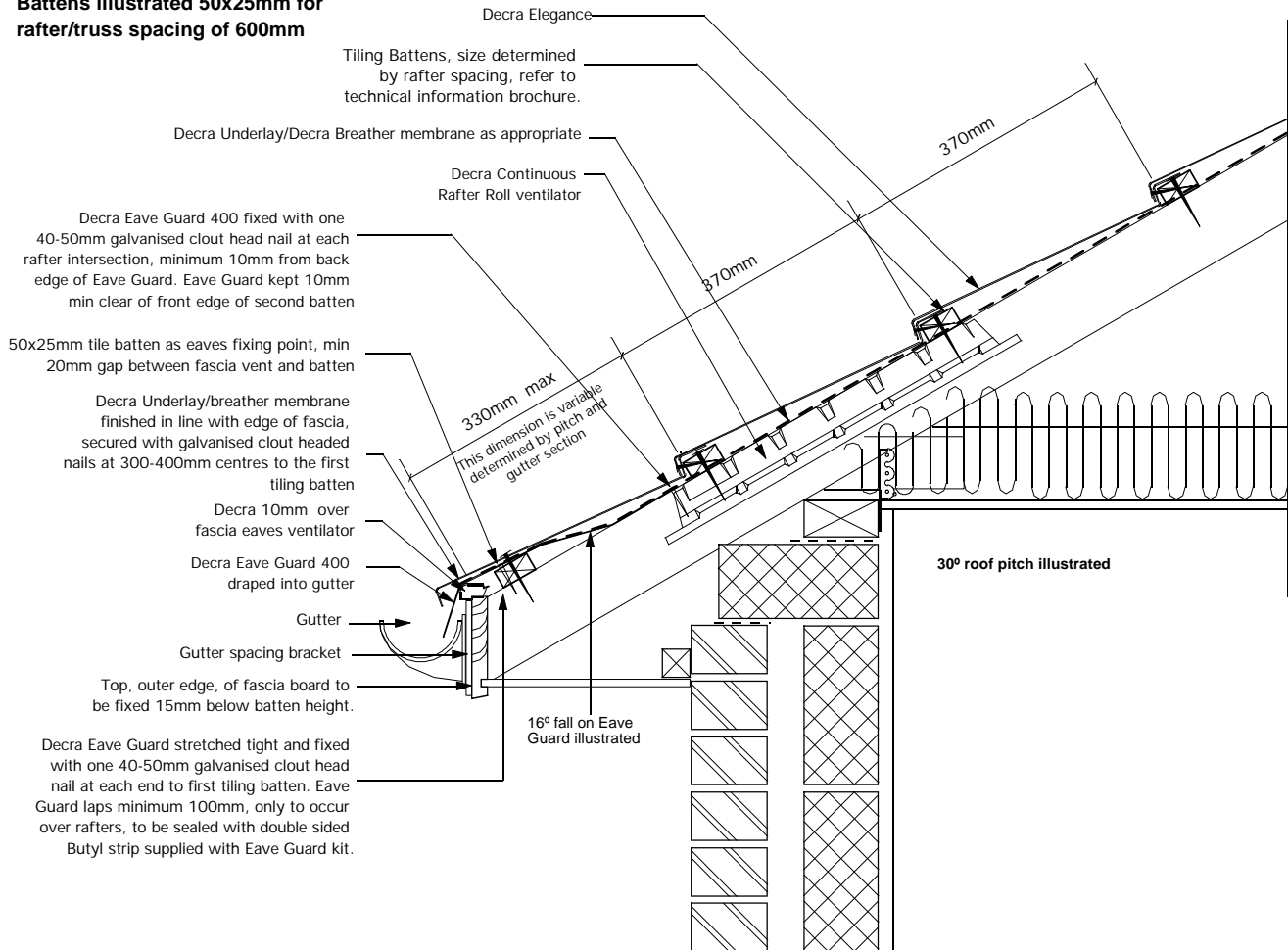

At low roof pitches care must be taken when setting out the underlying roof structure that ponding does not occur.

Eaves Detail greater than 15° roof pitch

Scale 1:10

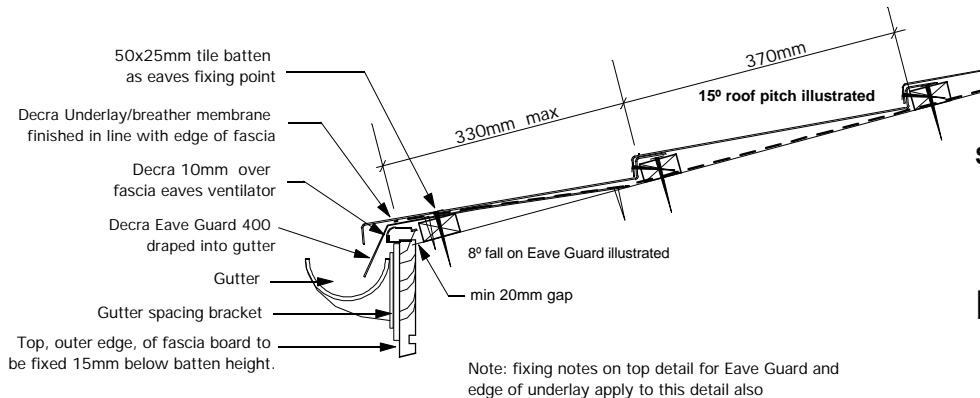

See notes for roof pitches below 15°

Eaves Detail 15°

Scale 1:10

Notes:

This detail drawing is to be read in conjunction with the Decra Eave Gaurd 400 installation instructions.

Decra Eaves Gaurd has a front and back edge. It is essential that it is installed the right way round with the front edge draped into the gutter and the textured edge on top.

The 10mm eaves ventilator cannot be used where roof pitches are below 15°, the Decra 25mm over fascia vent should be used instead. For further information on ventilation recommendations see the information section of the Decra Technical Services CD, and see drawing No DESE017 for the lower pitched, 600mm rafter spacing detail using the 25mm vent.

On eaves course of tile, the tiles are fixed vertically through the high point of the tile into the batten directly behind the fascia with Decra Nails. The nail heads to be covered with a finishing kit (supplied by Decra).



Decra®
Roof Systems Limited

A member of the Icopal Group



Unit 4
Crompton Fields
Crompton Way
Crawley
West Sussex
RH10 9QB

telephone: (01293) 545058/9

fax: (01293) 562709

email: technical@decra.co.uk

web-Site: <http://www.decra.co.uk>

The copyright of this drawing and detail information belongs to Decra Roof Systems Limited. Reproduction or amendment outwith the terms of the licensing agreement by other parties is expressly forbidden.

DECRA ELEGANCE

CONTENT

EAVES DETAIL

USING EAVE GUARD 400

10MM EAVES VENT AND 600MM RAFTER SPACING

DRAWING SCALE

1:10

DATE

15/04/03

DRAWING NO

DESE015

REVISION

**Battens illustrated 50x50mm
for rafter/truss spacing of 900
& 1200mm**

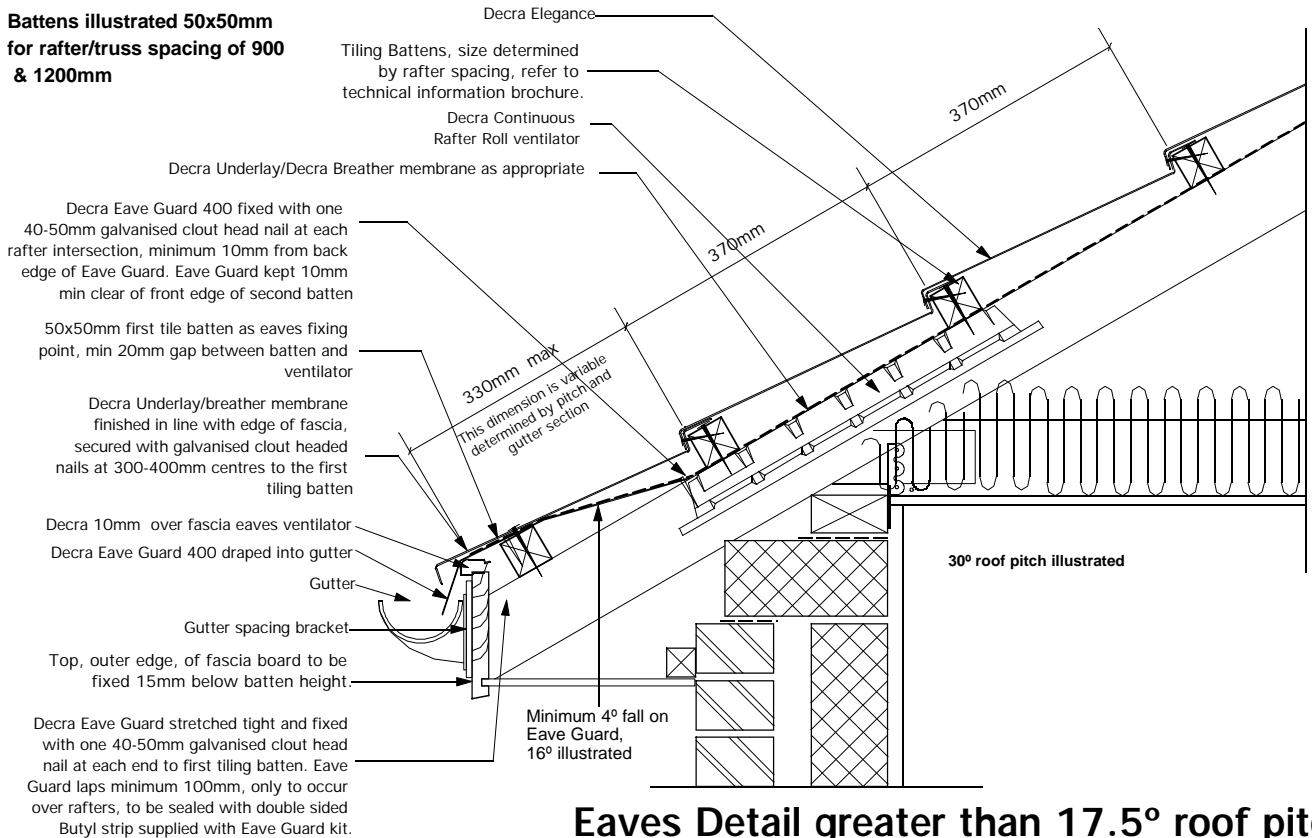

Eaves Detail greater than 17.5° roof pitch

Scale 1:10

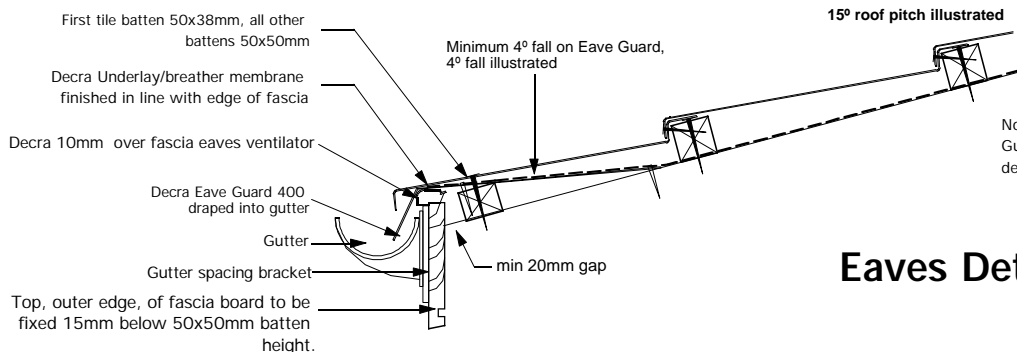

For lower roof pitches care must be taken when setting out the underlying roof structure that ponding does not occur.

Note: fixing notes on top detail for Eave Guard and edge of underlay apply to this detail also

Eaves Detail 15° to 17.5°

Scale 1:10

See notes for roof pitches below 15°

Notes:

This detail drawing is to be read in conjunction with the Decra Eave Gaurd 400 installation instructions.

Decra Eaves Gaurd has a front and back edge. It is essential that it is installed the right way round with the front edge draped into the gutter and the textured edge on top.

The 10mm eaves ventilator cannot be used where roof pitches are below 15°, the Decra 25mm over fascia vent should be used instead. For further information on ventilation recommendations see the information section of the Decra Technical Services CD, and see drawing No DESE018 for the lower pitched, wider rafter spacing detail using the 25mm vent.

On eaves course of tile, the tiles are fixed vertically through the high point of the tile into the batten directly behind the fascia with Decra Nails. The nail heads to be covered with a finishing kit (supplied by Decra).

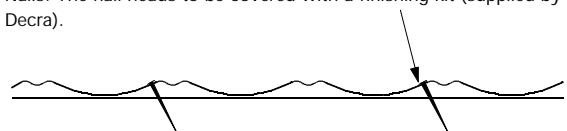

Decra®
Roof Systems Limited

A member of the Icopal Group



Unit 4
Crompton Fields
Crompton Way
Crawley
West Sussex
RH10 9QB

telephone: (01293) 545058/9

fax: (01293) 562709

email: technical@decra.co.uk

web-Site: <http://www.decra.co.uk>

The copyright of this drawing and detail information belongs to Decra Roof Systems Limited. Reproduction or amendment outwith the terms of the licensing agreement by other parties is expressly forbidden.

DECRA ELEGANCE

CONTENT

EAVES DETAIL

**USING EAVE GUARD 400, 10MM EAVES VENT
AND 900MM/1200MM RAFTER SPACING**

DRAWING SCALE

1:10

DATE

15/04/03

DRAWING NO

DESE016

REVISION

Battens illustrated 50x25mm for rafter/truss spacing of 600mm

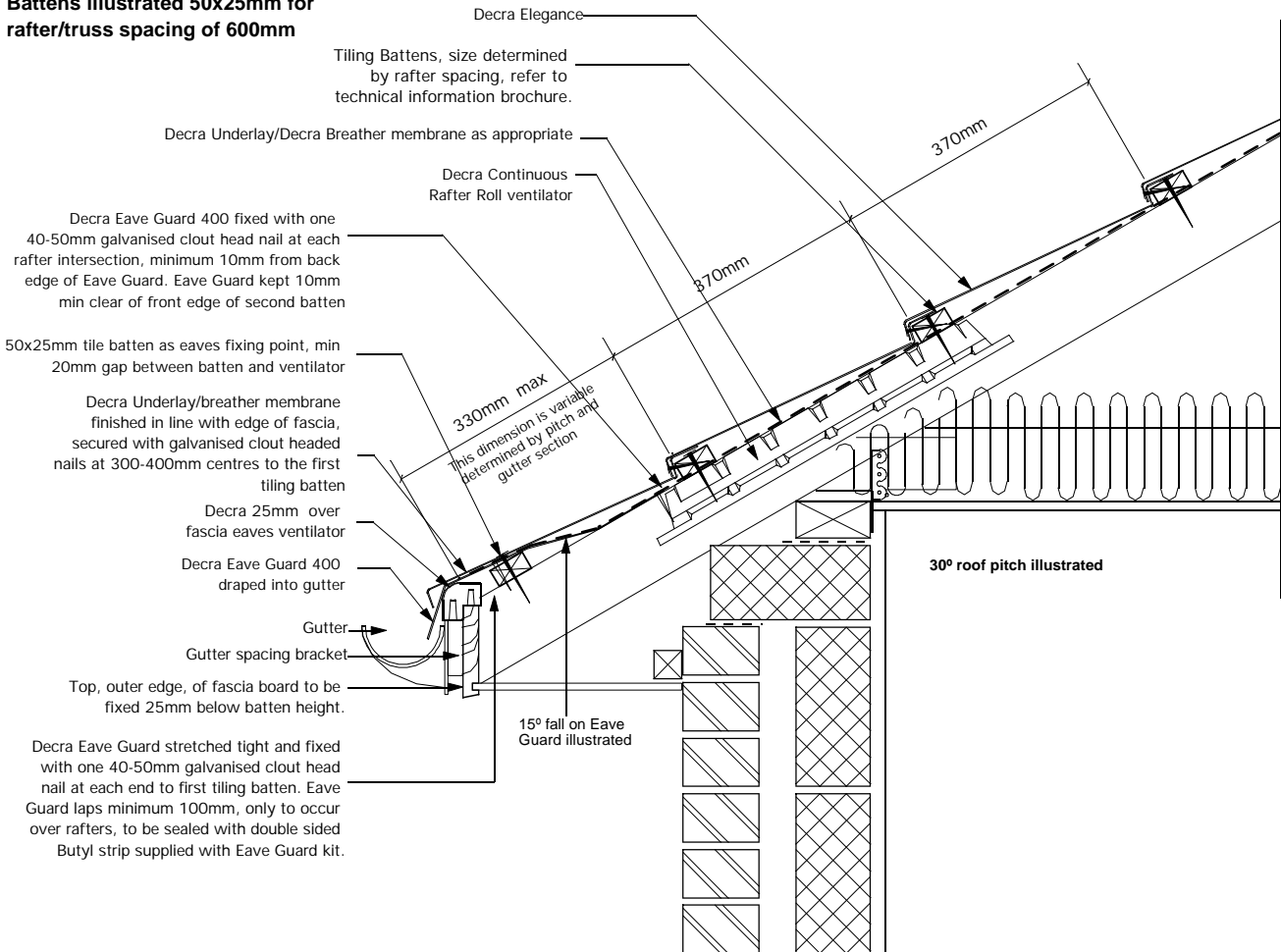

At low roof pitches care must be taken when setting out the underlying roof structure that ponding does not occur.

Eaves Detail greater than 15° roof pitch

Scale 1:10

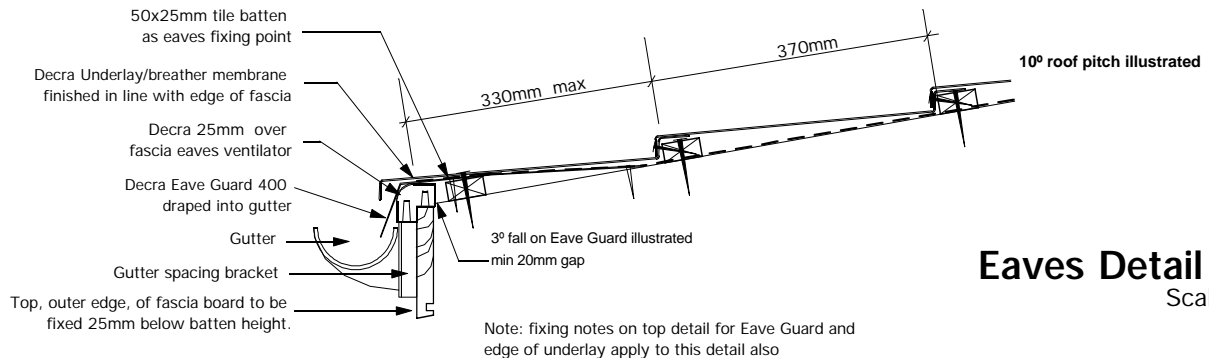

Eaves Detail 10°

Scale 1:10

Notes:

This detail drawing is to be read in conjunction with the Decra Eave Gaurd 400 installation instructions.

Decra Eaves Gaurd has a front and back edge. It is essential that it is installed the right way round with the front edge draped into the gutter and the textured edge on top.

On eaves course of tile, the tiles are fixed vertically through the high point of the tile into the batten directly behind the fascia with Decra Nails. The nail heads to be covered with a finishing kit (supplied by Decra).



Decra®
Roof Systems Limited

A member of the Icopal Group



Unit 4
Crompton Fields
Crompton Way
Crawley
West Sussex
RH10 9QB

telephone: (01293) 545058/9

fax: (01293) 562709

email: technical@decra.co.uk

web-Site: <http://www.decra.co.uk>

The copyright of this drawing and detail information belongs to Decra Roof Systems Limited. Reproduction or amendment outwith the terms of the licensing agreement by other parties is expressly forbidden.

DECRA ELEGANCE

CONTENT

EAVES DETAIL

USING EAVE GUARD 400, 25MM EAVES VENT AND 600MM RAFTER SPACING

DRAWING SCALE

1:10

DATE

15/04/03

DRAWING NO

DESE017

REVISION

Battens illustrated 50x50mm for rafter/truss spacing of 900 & 1200mm

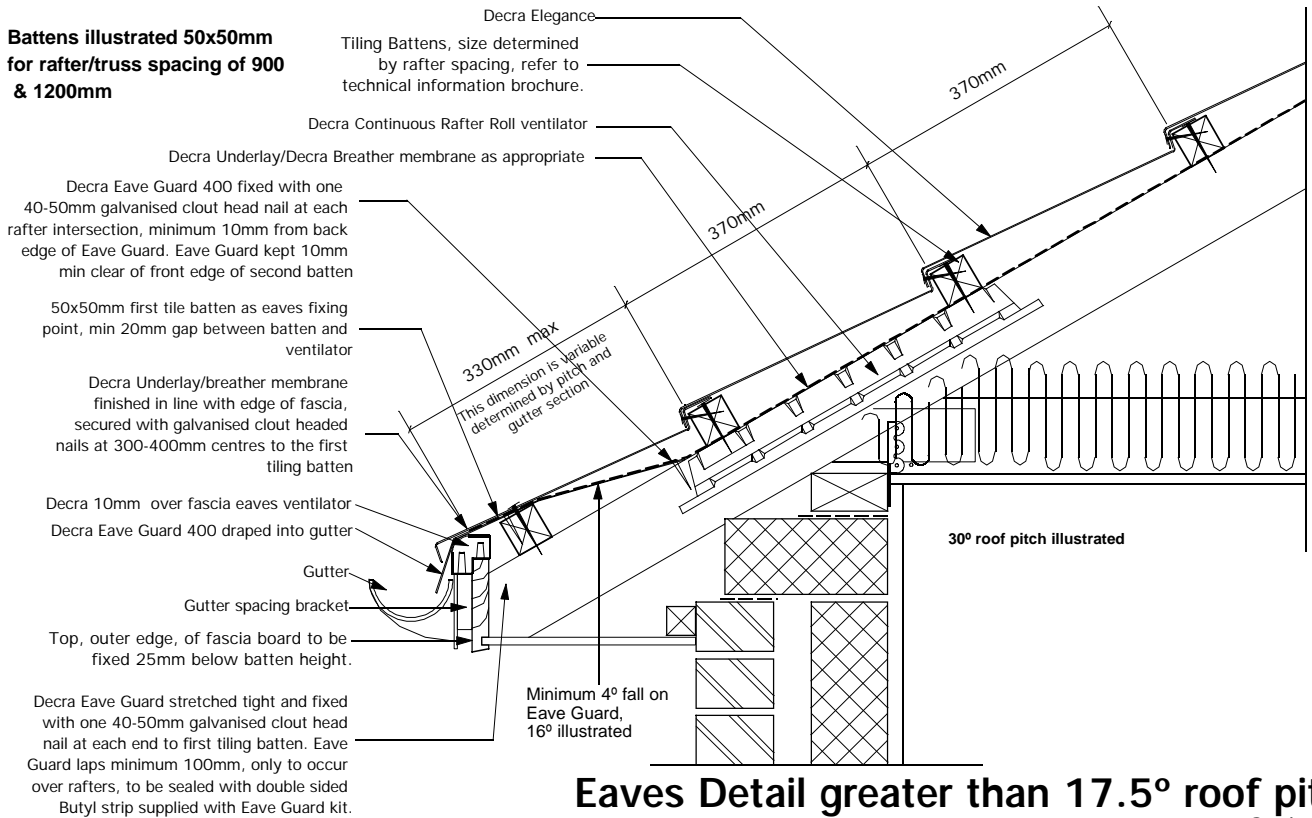

Eaves Detail greater than 17.5° roof pitch

Scale 1:10

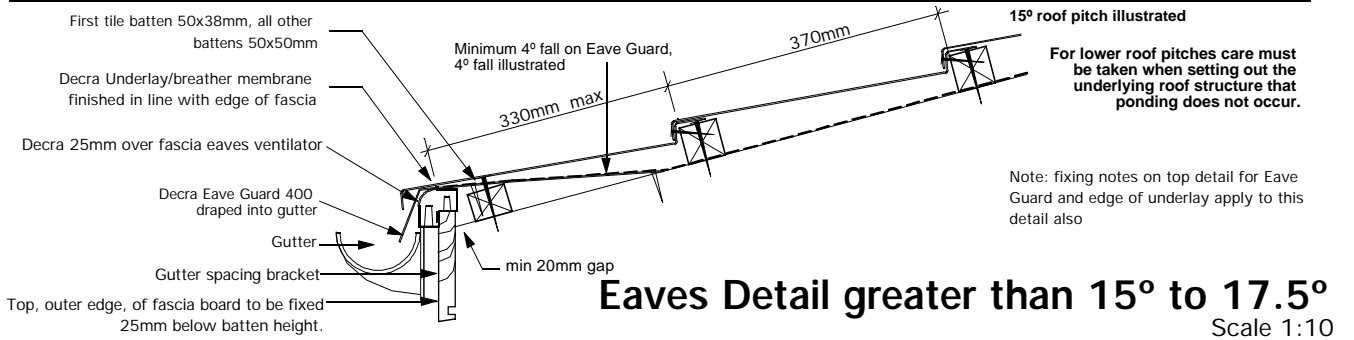

Eaves Detail greater than 15° to 17.5°

Scale 1:10

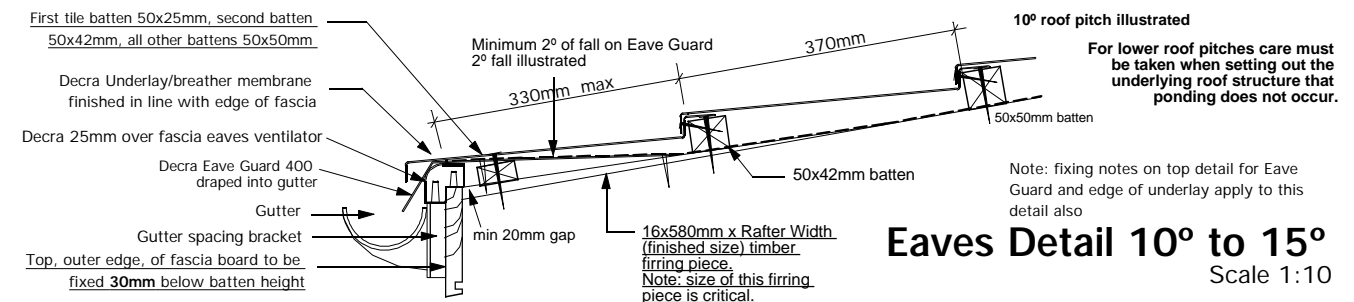

Eaves Detail 10° to 15°

Scale 1:10

Notes:

This detail drawing is to be read in conjunction with the Decra Eave Gaurd 400 installation instructions.

Decra Eaves Gaurd has a front and back edge. It is essential that it is installed the right way round with the front edge draped into the gutter and the textured edge on top.

On eaves course of tile, the tiles are fixed vertically through the high point of the tile into the batten directly behind the fascia with Decra Nails. The nail heads to be covered with a finishing kit (supplied by Decra).



Decra®
Roof Systems Limited

A member of the Icopal Group



Unit 4
Crompton Fields
Crompton Way
Crawley
West Sussex
RH10 9QB

telephone: (01293) 545058/9

fax: (01293) 562709

email: technical@decra.co.uk

web-Site: <http://www.decra.co.uk>

The copyright of this drawing and detail information belongs to Decra Roof Systems Limited. Reproduction or amendment outwith the terms of the licensing agreement by other parties is expressly forbidden.

DECRA ELEGANCE

CONTENT
**EAVES DETAIL USING
EAVE GUARD 400, 25MM EAVES VENT
AND 900MM/1200MM RAFTER SPACING**

DRAWING SCALE	1:10	DATE	15/04/03
DRAWING NO	DESE018	REVISION	

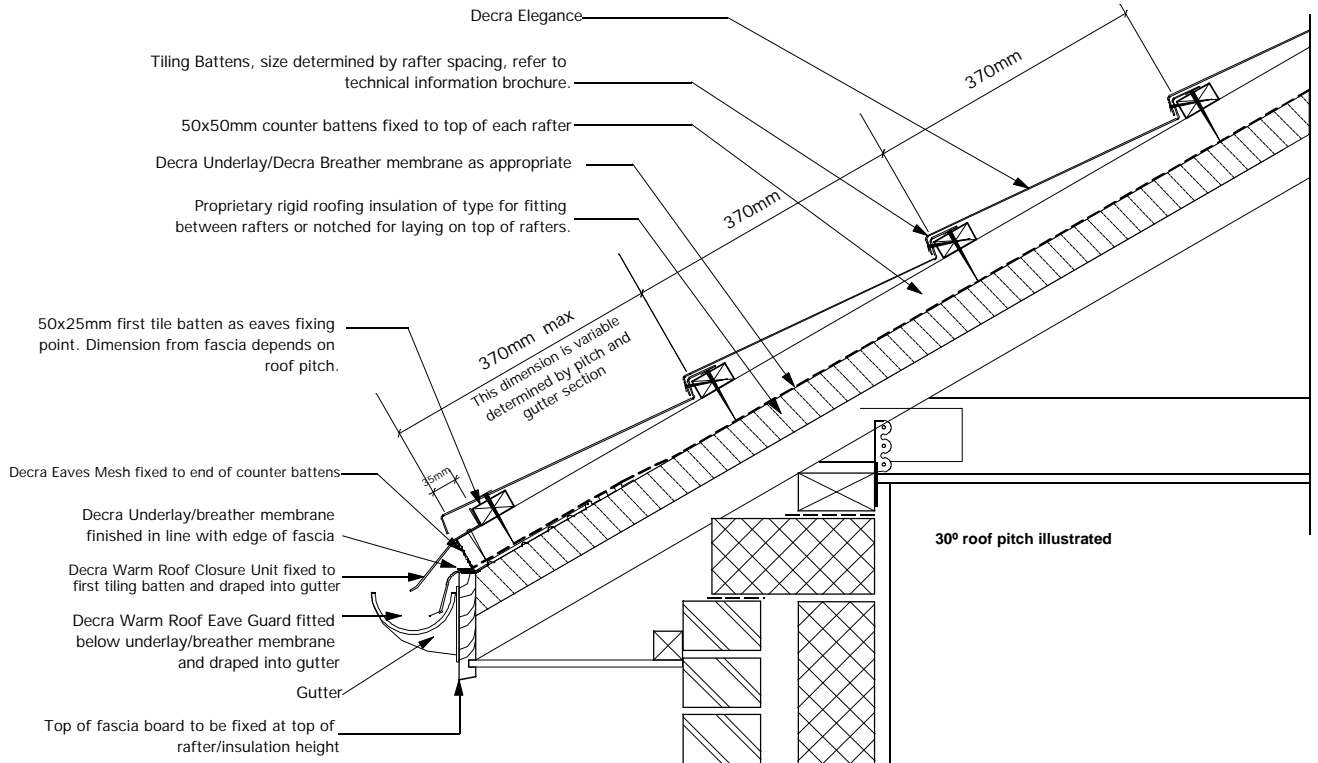

Warm Roof Eaves Detail
Scale 1:10

Care should be taken to ensure a 25mm air passageway gap is maintained between the warm roof closure unit and the warm roof eave guard. At steep pitches the angle of the oversailing section of the warm roof closure unit can be adjusted to ensure this airgap is present.

Notes:

This detail drawing is to be read in conjunction with the Decra Warm Roof Eave Guard, and Decra Warm Roof Closure installation instructions.

Insulation thickness shown is indicative. Where warm roof structures are being used, checks for interstitial condensation must be carried out by the designer. Thicknesses of insulation required by the building regulations vary for different building classifications. Refer to manufacturer's technical literature.

On eaves course of tile, the tiles are fixed vertically through the high point of the tile into the batten directly behind the fascia with Decra Nails. The nail heads to be covered with a finishing kit (supplied by Decra).



Decra®
Roof Systems Limited
A member of the Icopal Group



Unit 4
Crompton Fields
Crompton Way
Crawley
West Sussex
RH10 9QB

telephone: (01293) 545058/9
fax: (01293) 562709
email: technical@decra.co.uk
web-Site: <http://www.decra.co.uk>

DECRA ELEGANCE

CONTENT **WARM ROOF EAVES DETAIL
USING DECRA WARM ROOF EAVE GUARD &
EAVE CLOSURE, & DECRA MESH**

DRAWING SCALE	1:10	DATE	15/04/03
DRAWING NO	DESE019	REVISION	

The copyright of this drawing and detail information belongs to Decra Roof Systems Limited. Reproduction or amendment outwith the terms of the licensing agreement by other parties is expressly forbidden.

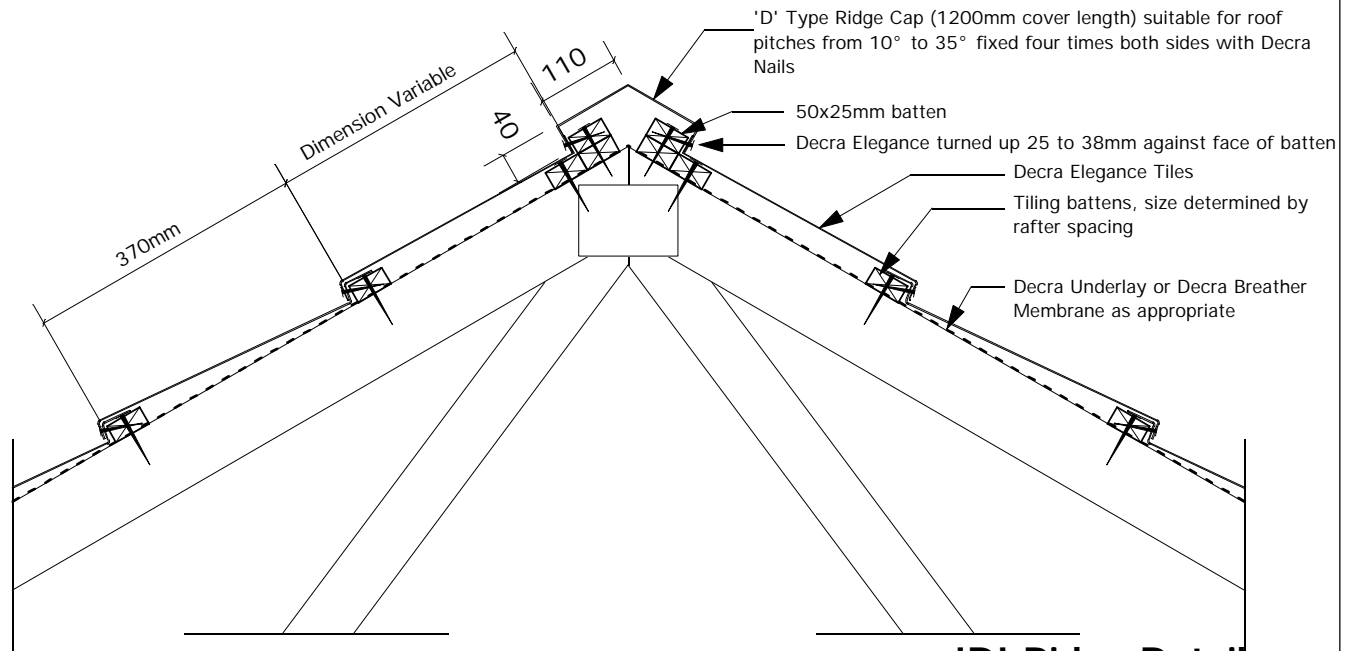

'D' Ridge Detail
Scale 1:10

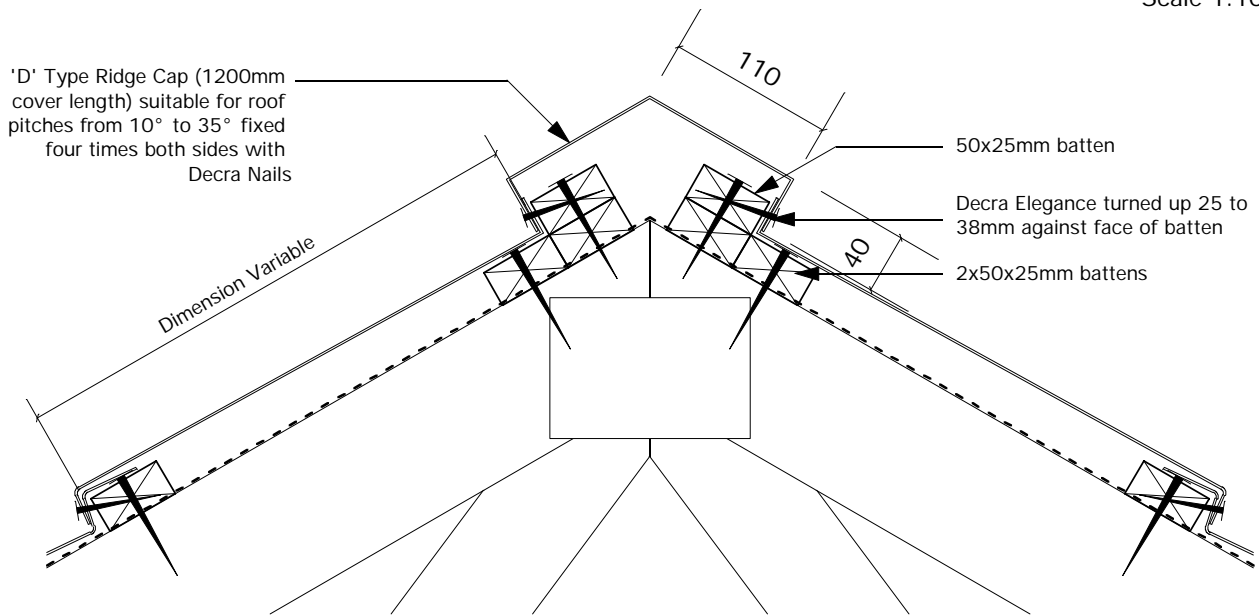

'D' Ridge Detail
Scale 1:5

Notes:

Decra®
Roof Systems Limited

A member of the Icopal Group



Unit 4
Crompton Fields
Crompton Way
Crawley
West Sussex
RH10 9QB

telephone: (01293) 545058/9

fax: (01293) 562709

email: technical@decra.co.uk

web-Site: <http://www.decra.co.uk>

The copyright of this drawing and detail information belongs to Decra Roof Systems Limited. Reproduction or amendment outwith the terms of the licensing agreement by other parties is expressly forbidden.

DECRA ELEGANCE

CONTENT

**DECRA ELEGANCE
UNVENTILATED 'D' RIDGE DETAIL**

DRAWING SCALE **1:5/10**

DATE **07/09/98**

DRAWING NO **DESE020**

REVISION

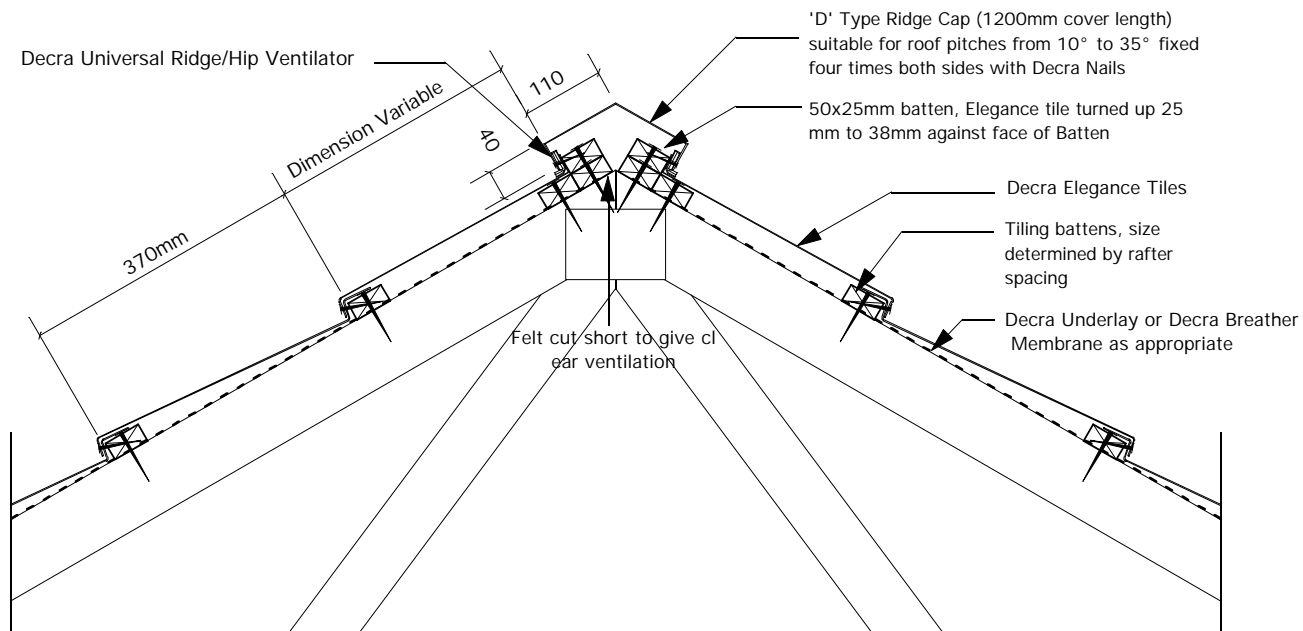

Vented 'D' Ridge Detail
Scale 1:10

Notes:

Decra[®]
Roof Systems Limited
A member of the Icopal Group



Unit 4
Crompton Fields
Crompton Way
Crawley
West Sussex
RH10 9QB

telephone: (01293) 545058/9
fax: (01293) 562709
email: technical@decra.co.uk
web-Site: <http://www.decra.co.uk>

The copyright of this drawing and detail information belongs to Decra Roof Systems Limited. Reproduction or amendment outwith the terms of the licensing agreement by other parties is expressly forbidden.

DECRA ELEGANCE		
CONTENT	DECRA ELEGANCE VENTILATED 'D' RIDGE DETAIL USING UNIVERSAL D RIDGE VENTILATOR	
DRAWING SCALE	1:10	DATE 07/09/98
DRAWING NO	DESE021	REVISION

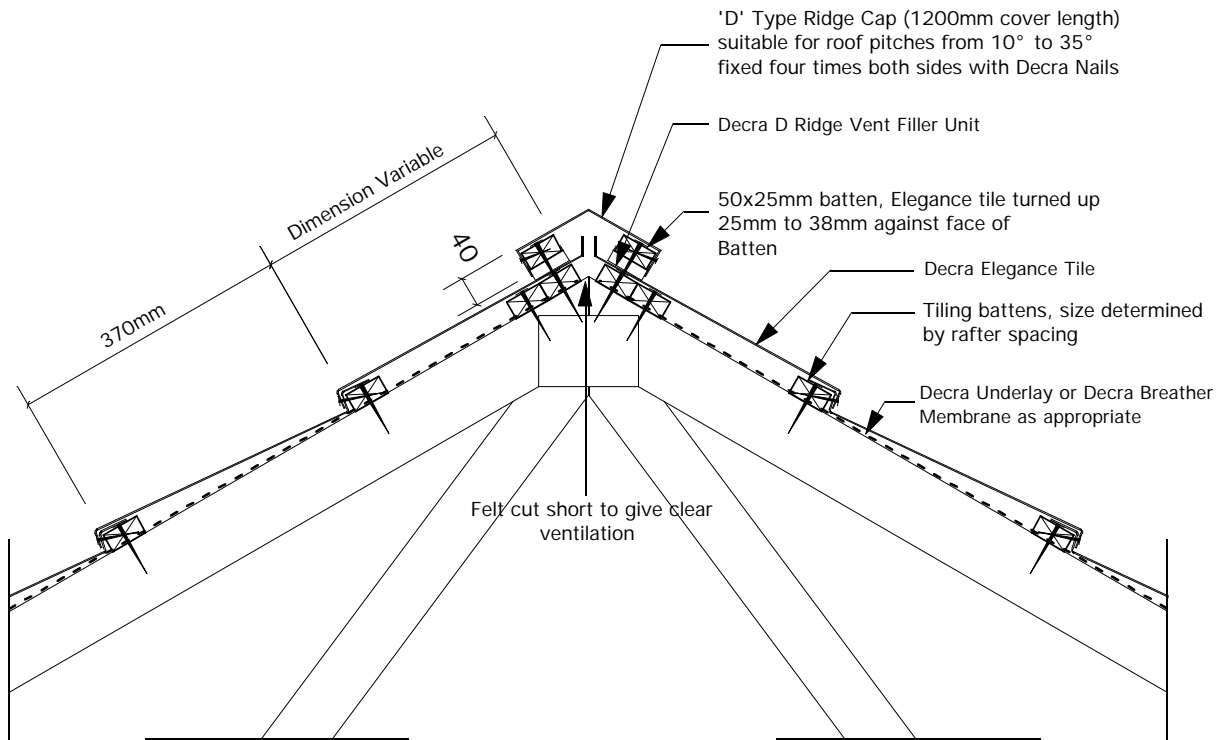

Vented 'D' Ridge Detail

Scale 1:10

Notes:

Decra®
Roof Systems Limited

A member of the Icopal Group



Unit 4
Crompton Fields
Crompton Way
Crawley
West Sussex
RH10 9QB

telephone: (01293) 545058/9

fax: (01293) 562709

email: technical@decra.co.uk

web-Site: <http://www.decra.co.uk>

The copyright of this drawing and detail information belongs to Decra Roof Systems Limited. Reproduction or amendment outwith the terms of the licensing agreement by other parties is expressly forbidden.

DECRA ELEGANCE

CONTENT
**DECRA ELEGANCE
VENTILATED 'D' RIDGE DETAIL
USING DECRA D RIDGE VENT FILLER UNIT**

DRAWING SCALE	1:10	DATE	07/09/98
---------------	-------------	------	-----------------

DRAWING NO	DESE022	REVISION	
------------	----------------	----------	--

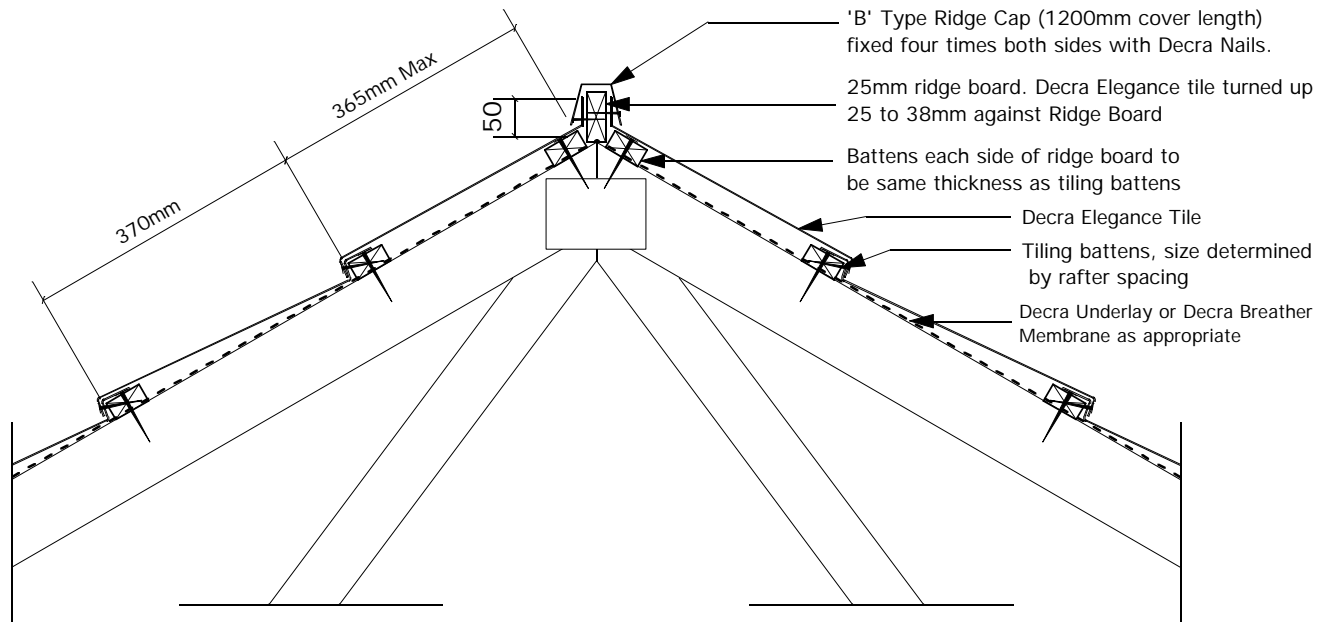

'B' Ridge Detail
Scale 1:10

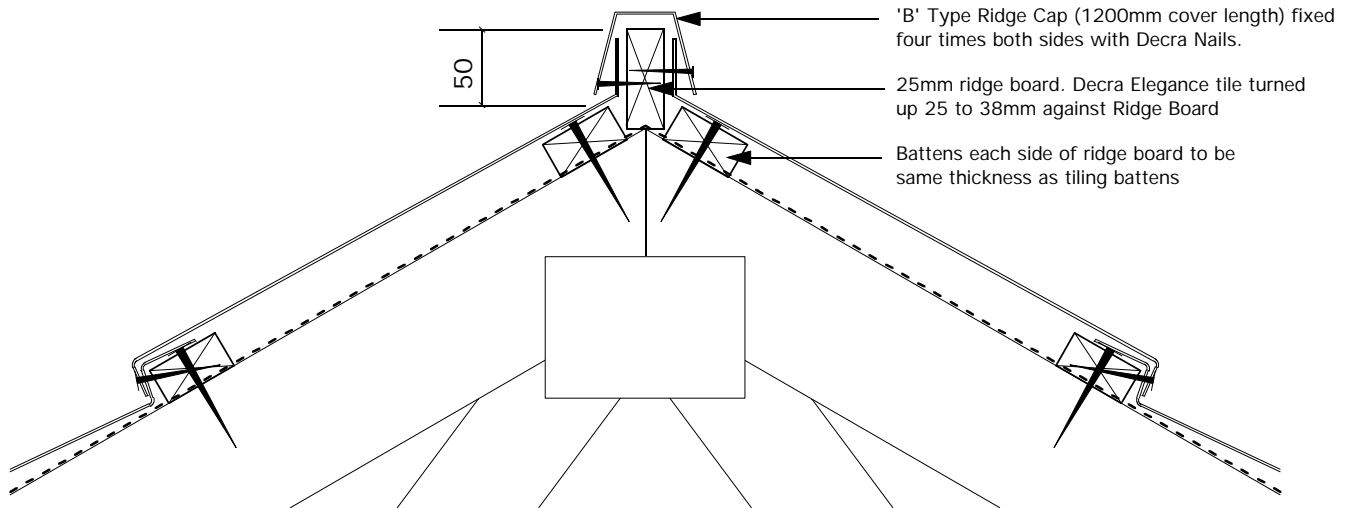

'B' Ridge Detail
Scale 1:5

Notes:

Decra[®]
Roof Systems Limited

A member of the Icopal Group



Unit 4
Crompton Fields
Crompton Way
Crawley
West Sussex
RH10 9QB

telephone: (01293) 545058/9

fax: (01293) 562709

email: technical@decra.co.uk

web-Site: <http://www.decra.co.uk>

The copyright of this drawing and detail information belongs to Decra Roof Systems Limited. Reproduction or amendment outwith the terms of the licensing agreement by other parties is expressly forbidden.

DECRA ELEGANCE

CONTENT

**DECRA ELEGANCE
'B' RIDGE DETAILS**

DRAWING SCALE

1:5/10

DATE

07/09/98

DRAWING NO

DESE023

REVISION

Universal D Ridge/Hip ventilator blanking pieces 1200mm long each side in length along ridge, centred on flue tile centre, to each side of gas flue terminal tile. Ventilation blanking pieces only used if rest of ridge is being ventilated with universal ridge ventilator.

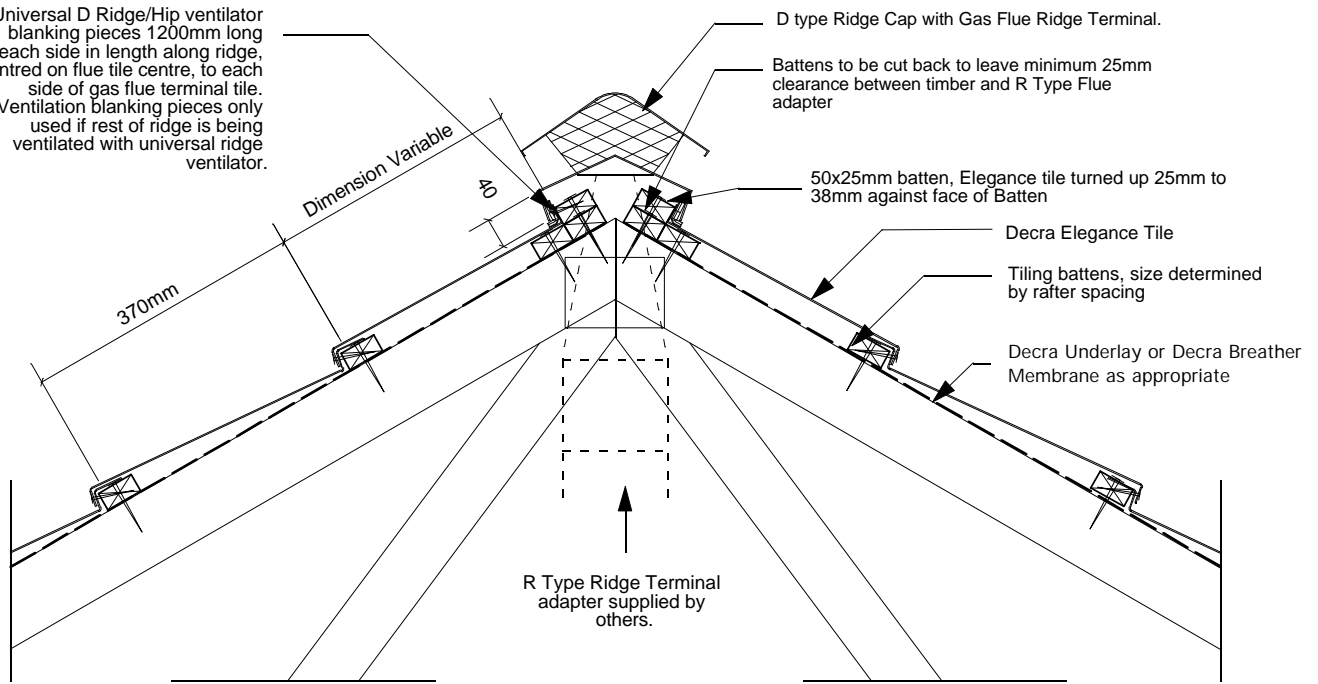

Ridge Detail

Scale 1:10

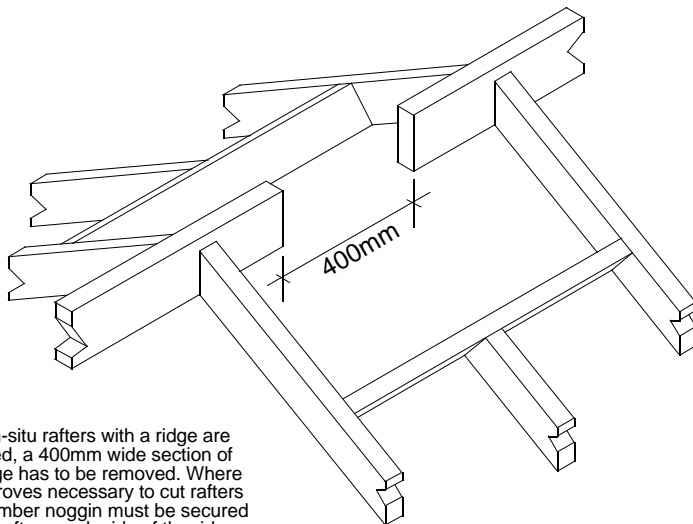

If in-situ rafters with a ridge are used, a 400mm wide section of ridge has to be removed. Where it proves necessary to cut rafters a timber noggin must be secured to rafters each side of the ridge.

Cut Ridge Board Detail

Scale 1:20

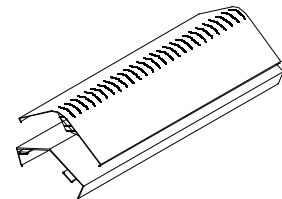

Flue Component Isometric

Scale 1:20

Notes:

To improve clearance between R Type adapter and flue terminal an extension piece (supplied by others) can be used.

This detail should be read in conjunction with the Gas Flue Terminal Installation Instructions. This is located on the Decra Technical Services CD, or may be obtained from Decra Roof Systems.

Decra[®]
Roof Systems Limited

A member of the Icopal Group



Unit 4
Crompton Fields
Crompton Way
Crawley
West Sussex
RH10 9QB

telephone: (01293) 545058/9

fax: (01293) 562709

email: technical@decra.co.uk

web-Site: <http://www.decra.co.uk>

The copyright of this drawing and detail information belongs to Decra Roof Systems Limited. Reproduction or amendment outwith the terms of the licensing agreement by other parties is expressly forbidden.

DECRA ELEGANCE

CONTENT

**DECRA ELEGANCE
D RIDGE FLUE TERMINAL TILE**

DRAWING SCALE

1:10/20

DATE

07/09/98

DRAWING NO

DESE027

REVISION

Decra 'B' type capping fitted over hip board and fixed 4 times each side (using Decra Nails) through hip capping and tile upstand into the hip board.

Hip board formed using 25mm thick timber

Continuous batten to each side of hip rafter

Decra Elegance tiles turned up 25mm in front of batten and nailed 4 times each side (using Decra Nails) through the hip capping and into the face of the batten

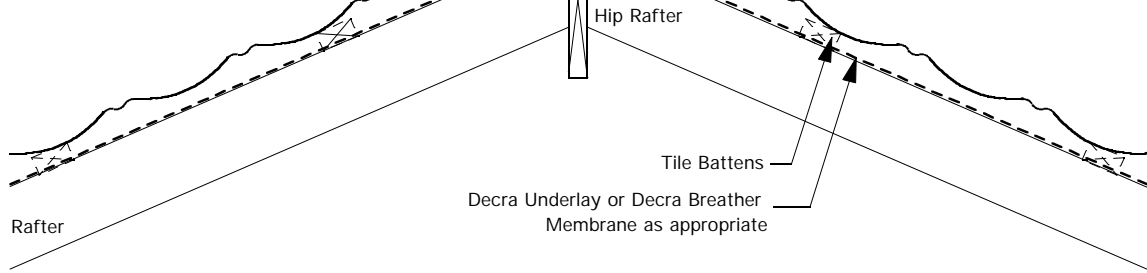

Hip Detail Using Decra 'B' Ridge

Scale 1:10

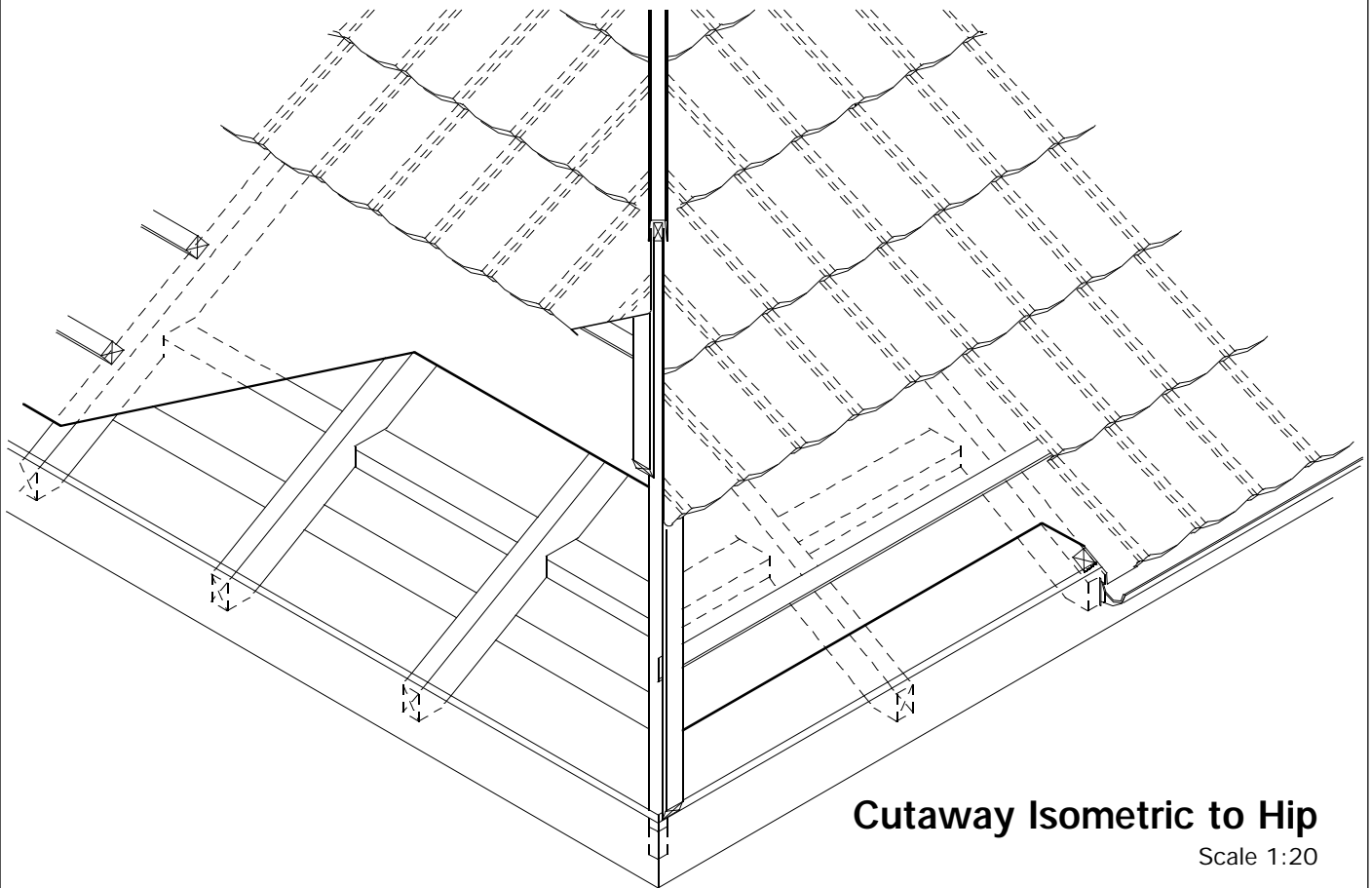

Cutaway Isometric to Hip

Scale 1:20

Notes:

Decra[®]
Roof Systems Limited

A member of the Icopal Group



Unit 4
Crompton Fields
Crompton Way
Crawley
West Sussex
RH10 9QB

telephone: (01293) 545058/9
fax: (01293) 562709

email: technical@decra.co.uk
web-Site: <http://www.decra.co.uk>

The copyright of this drawing and detail information belongs to Decra Roof Systems Limited. Reproduction or amendment outwith the terms of the licensing agreement by other parties is expressly forbidden.

DECRA ELEGANCE

CONTENT

**DECRA ELEGANCE
HIP DETAIL USING B TYPE RIDGE**

DRAWING SCALE **1:10/20**

DATE **07/09/98**

DRAWING NO **DESE030**

REVISION

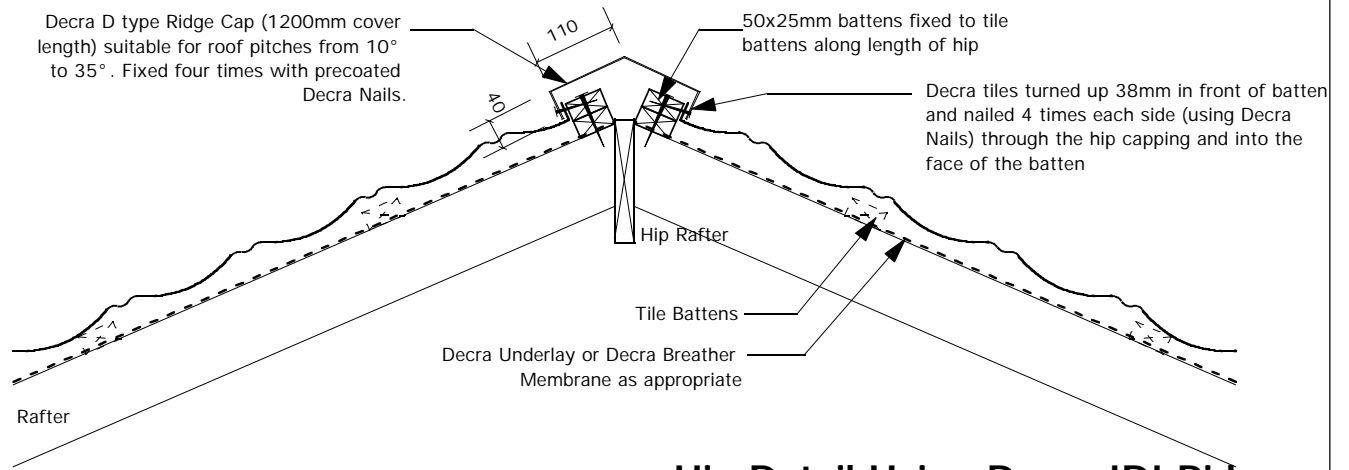

Hip Detail Using Decra 'D' Ridge

Scale 1:10

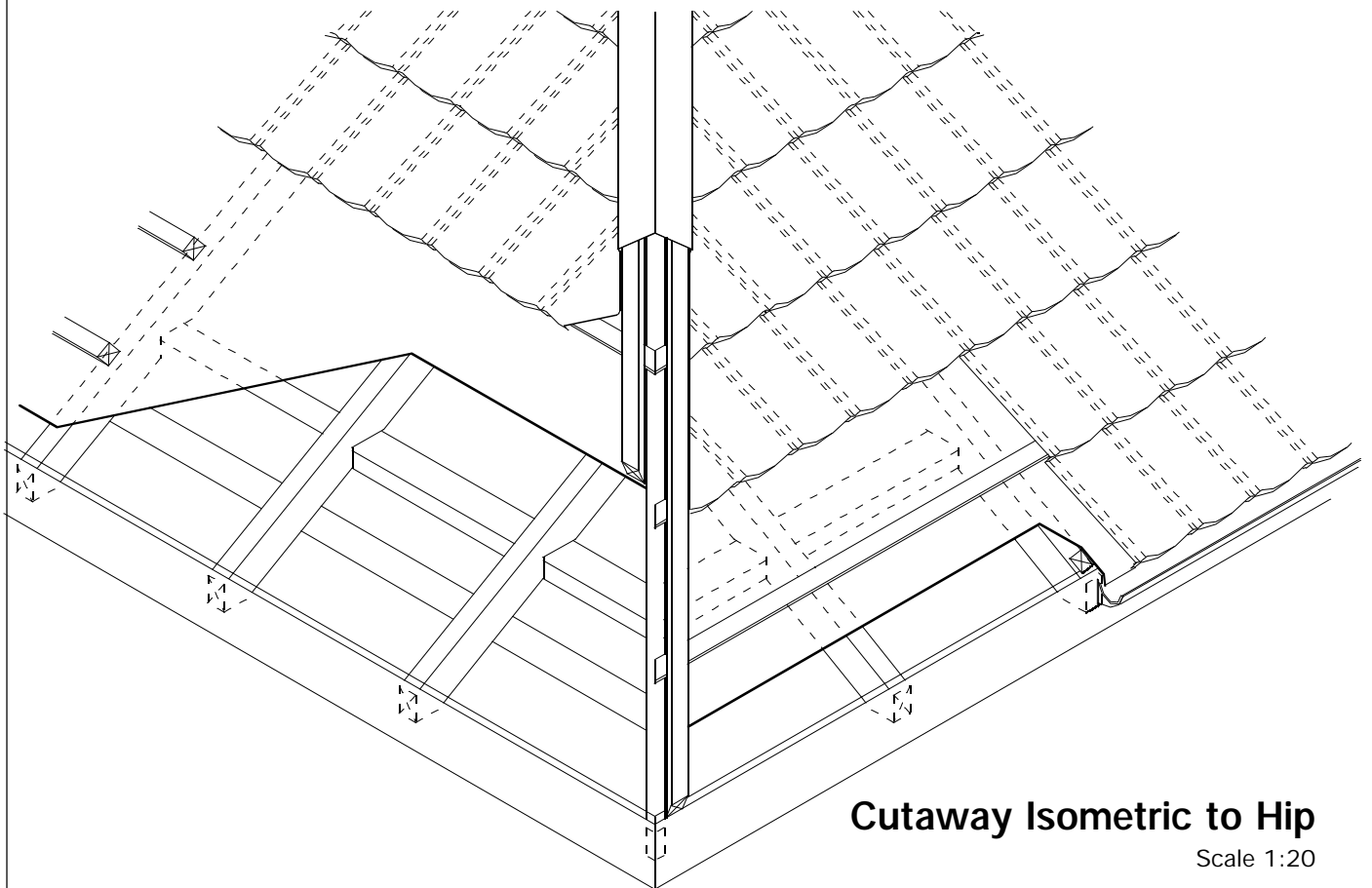

Cutaway Isometric to Hip

Scale 1:20

Notes:

Decra 'D' Ridge Hip End Closure Units are available

Decra[®]
Roof Systems Limited

A member of the Icopal Group



Unit 4
Crompton Fields
Crompton Way
Crawley
West Sussex
RH10 9QB

telephone: (01293) 545058/9

fax: (01293) 562709

email: technical@decra.co.uk

web-Site: <http://www.decra.co.uk>

The copyright of this drawing and detail information belongs to Decra Roof Systems Limited. Reproduction or amendment outwith the terms of the licensing agreement by other parties is expressly forbidden.

DECRA ELEGANCE

CONTENT

DECRA ELEGANCE
HIP DETAILS USING D TYPE RIDGE

DRAWING SCALE

1:10/20

DATE

07/09/98

DRAWING NO

DESE031

REVISION

Decra D type Ridge Cap (1200mm cover length) suitable for roof pitches from 10° to 35° . Fixed four times with pre-coated Decra Nails.

Decra Universal Hip and Ridge Vent

50x25mm battens fixed to tile battens along length of hip

Decra tiles turned up 38mm in front of batten and nailed 4 times each side (using Decra Nails) through the hip capping and into the face of the batten

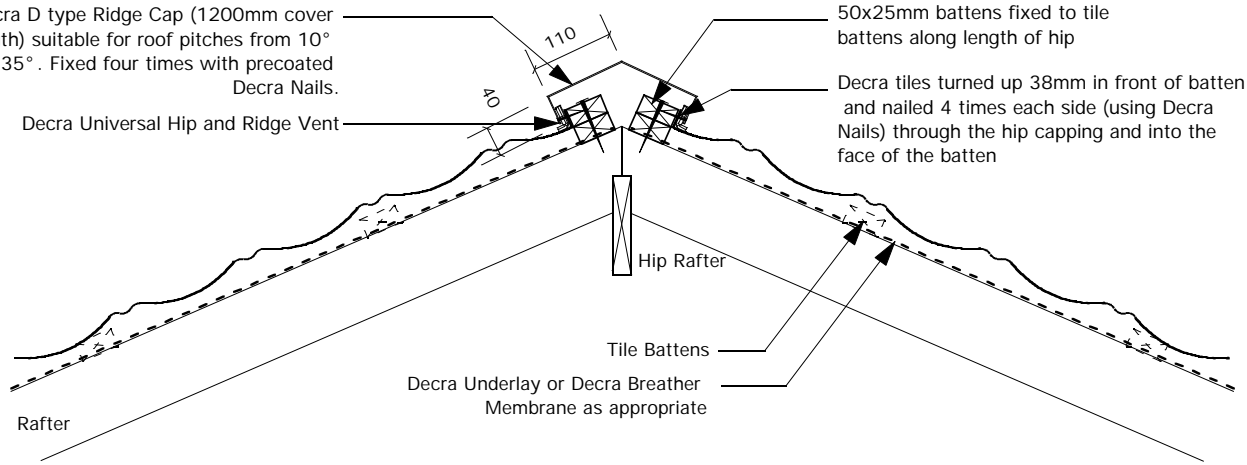

Hip Detail Using Decra 'D' Ridge

Scale 1:10

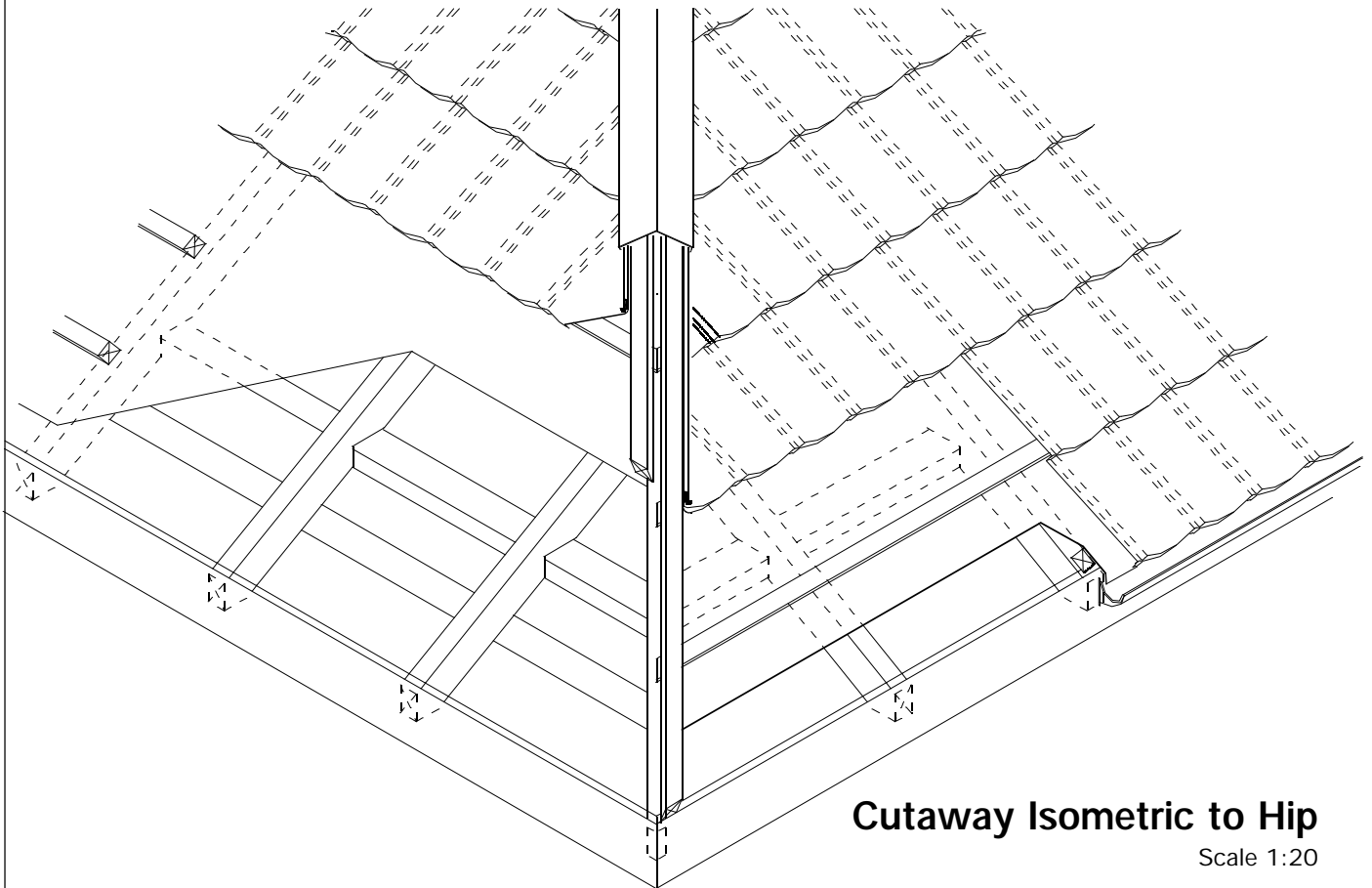

Cutaway Isometric to Hip

Scale 1:20

Notes:

Decra 'D' Ridge Hip End Closure Units are available

Decra[®]
Roof Systems Limited

A member of the Icopal Group



Unit 4
Crompton Fields
Crompton Way
Crawley
West Sussex
RH10 9QB

telephone: (01293) 545058/9

fax: (01293) 562709

email: technical@decra.co.uk

web-Site: <http://www.decra.co.uk>

The copyright of this drawing and detail information belongs to Decra Roof Systems Limited. Reproduction or amendment outwith the terms of the licensing agreement by other parties is expressly forbidden.

DECRA ELEGANCE

CONTENT

DECRA ELEGANCE
VENTILATED HIP DETAIL
USING D DTYPE RIDGE

DRAWING SCALE

1:10/20

DATE

07/09/98

DRAWING NO

DESE032

REVISION

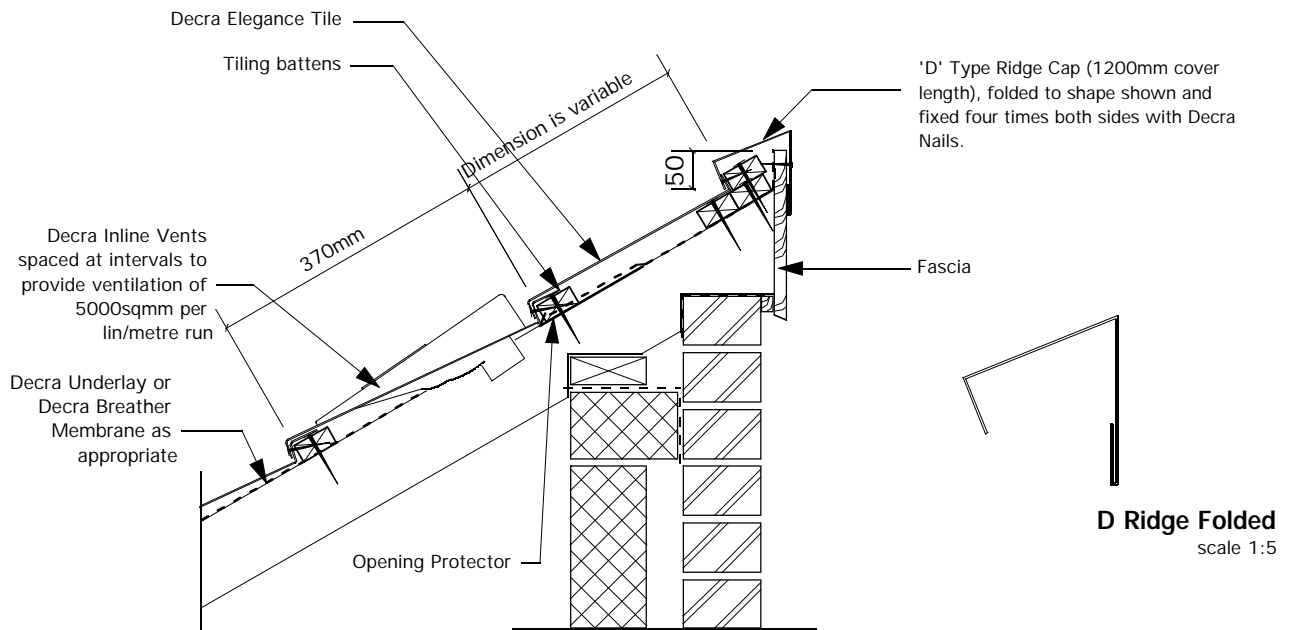

Mono Ridge Detail
Scale 1:10

Notes:

This detail suitable up to maximum 35° only

Decra®
Roof Systems Limited

A member of the Icopal Group



Unit 4
Crompton Fields
Crompton Way
Crawley
West Sussex
RH10 9QB

telephone: (01293) 545058/9

fax: (01293) 562709

email: technical@decra.co.uk

web-Site: <http://www.decra.co.uk>

The copyright of this drawing and detail information belongs to Decra Roof Systems Limited. Reproduction or amendment outwith the terms of the licensing agreement by other parties is expressly forbidden.

DECRA ELEGANCE

CONTENT

**DECRA ELEGANCE
MONO-RIDGE DETAILS
(D TYPE RIDGE)**

DRAWING SCALE

1:10

DATE

07/09/98

DRAWING NO

DESE040

REVISION

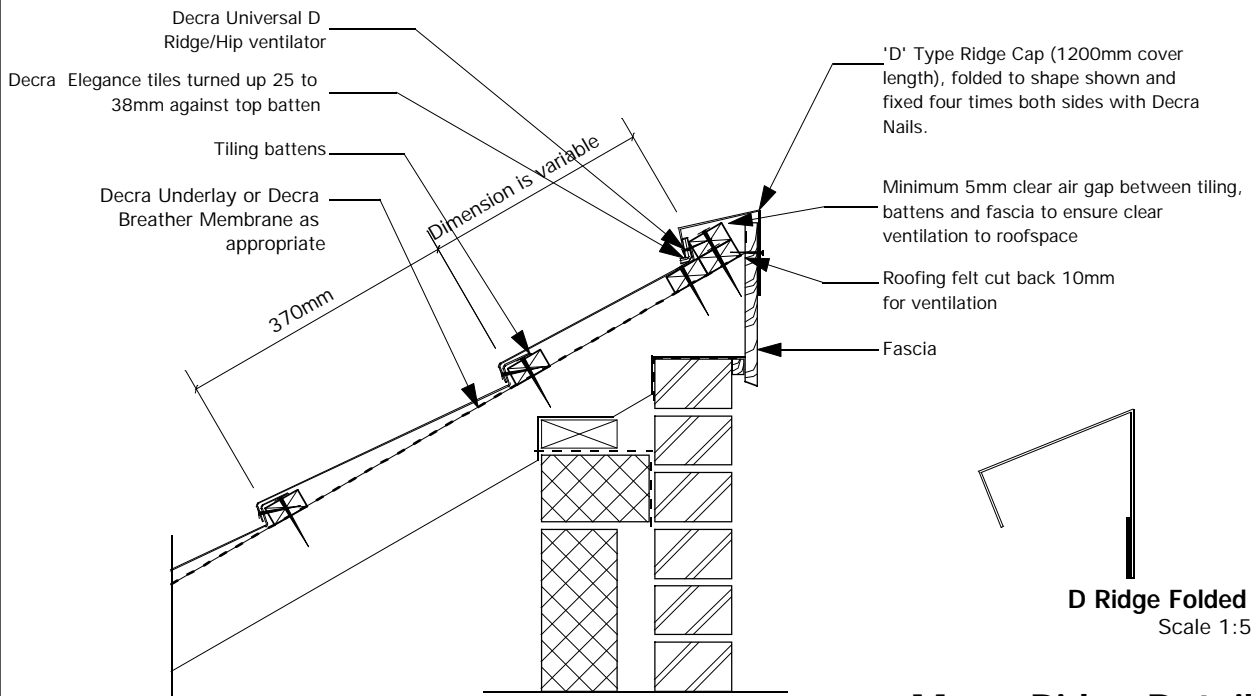

Mono Ridge Detail

Scale 1:10

Notes:

This detail suitable up to maximum 35° only

Decra[®]
Roof Systems Limited

A member of the Icopal Group



Unit 4
Crompton Fields
Crompton Way
Crawley
West Sussex
RH10 9QB

telephone: (01293) 545058/9

fax: (01293) 562709

email: technical@decra.co.uk

web-Site: <http://www.decra.co.uk>

The copyright of this drawing and detail information belongs to Decra Roof Systems Limited. Reproduction or amendment outwith the terms of the licensing agreement by other parties is expressly forbidden.

DECRA ELEGANCE

CONTENT
**DECRA ELEGANCE
MONO RIDGE DETAILS
D RIDGE WITH D RIDGE/HIP VENT**

DRAWING SCALE	1:10	DATE	07/09/98
DRAWING NO	DESE041	REVISION	

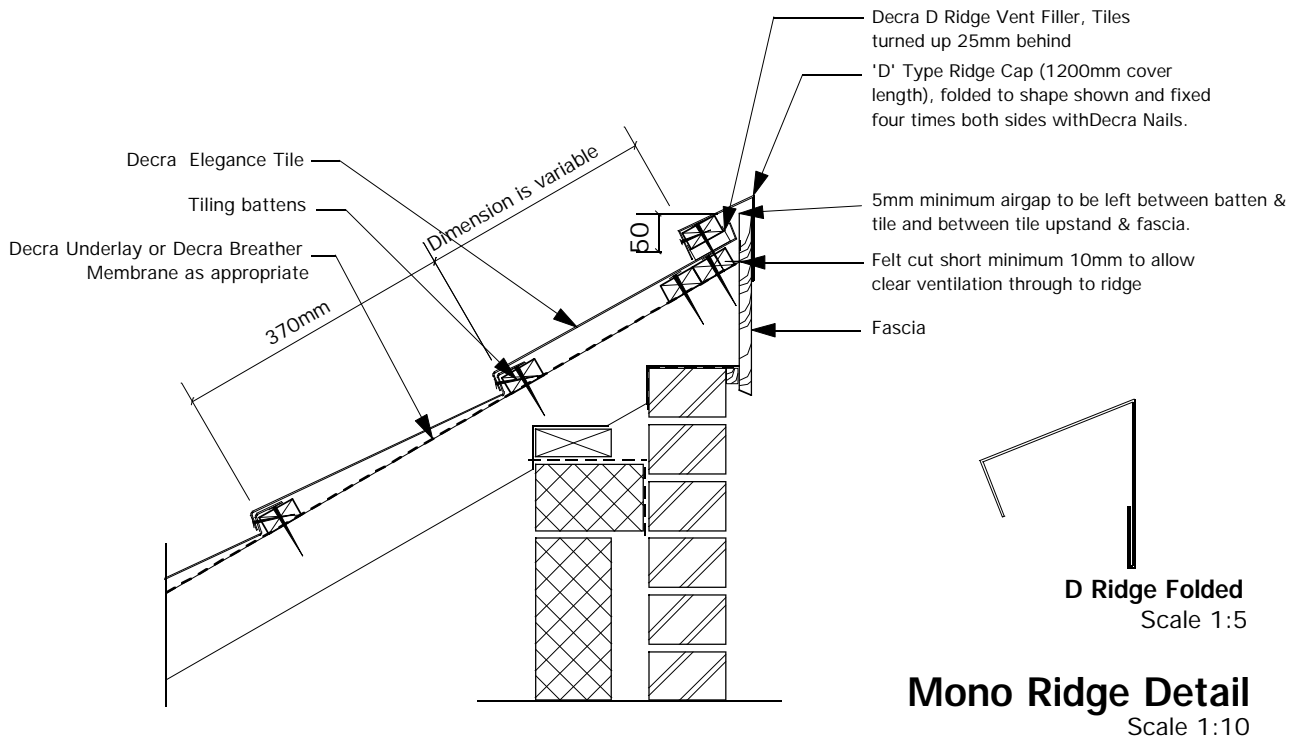

Notes:

This detail suitable up to maximum 35 degrees only

Decra®
Roof Systems Limited

A member of the Icopal Group



Unit 4
Crompton Fields
Crompton Way
Crawley
West Sussex
RH10 9QB

telephone: (01293) 545058/9
fax: (01293) 562709
email: technical@decra.co.uk
web-Site: <http://www.decra.co.uk>

The copyright of this drawing and detail information belongs to Decra Roof Systems Limited. Reproduction or amendment outwith the terms of the licensing agreement by other parties is expressly forbidden.

DECRA ELEGANCE

CONTENT
**DECRA ELEGANCE
MONO RIDGE DETAILS
D RIDGE USING D RIDGE VENT FILLER**

DRAWING SCALE	1:10	DATE	07/09/98
DRAWING NO	DESE042	REVISION	

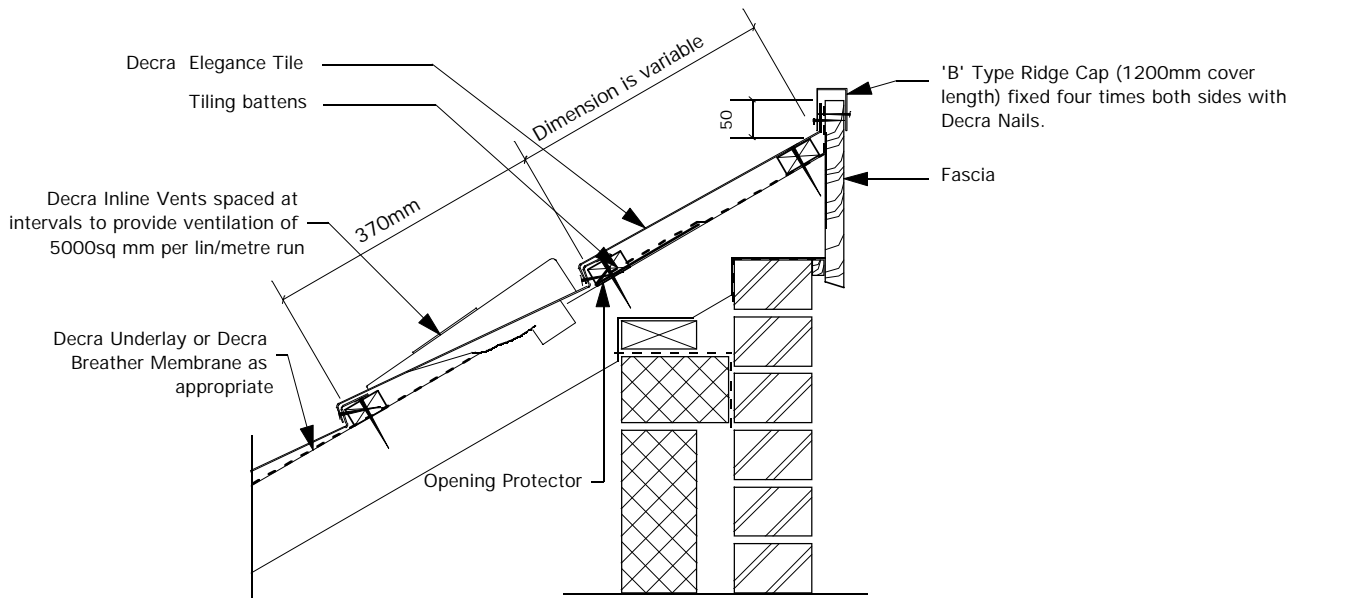

Mono Ridge Detail

Scale 1:10

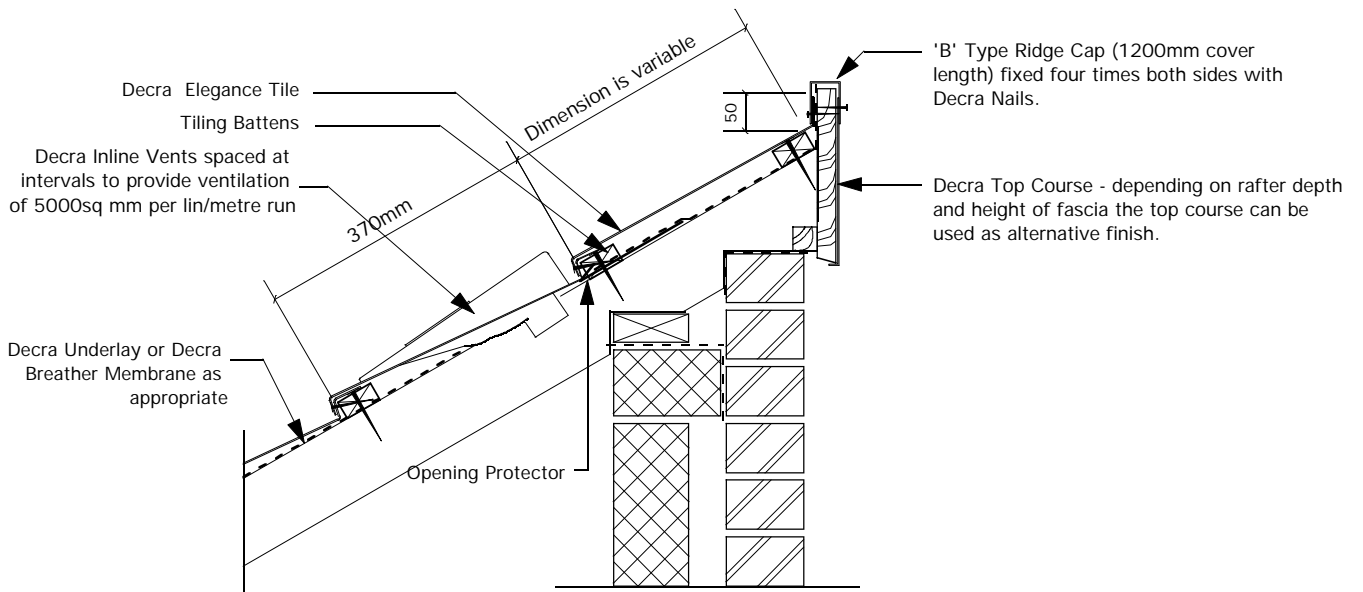

Alternative Mono Ridge Detail

Scale 1:10

Notes:

Decra®
Roof Systems Limited

A member of the Icopal Group



Unit 4
Crompton Fields
Crompton Way
Crawley
West Sussex
RH10 9QB

telephone: (01293) 545058/9

fax: (01293) 562709

email: technical@decra.co.uk

web-Site: <http://www.decra.co.uk>

The copyright of this drawing and detail information belongs to Decra Roof Systems Limited. Reproduction or amendment outwith the terms of the licensing agreement by other parties is expressly forbidden.

DECRA ELEGANCE

CONTENT

**DECRA ELEGANCE
MONO RIDGE DETAILS
B TYPE RIDGE**

DRAWING SCALE

1:10

DATE

07/09/98

DRAWING NO

DESE044

REVISION

Decra Elegance
 Tile Batten
 Decra Underlay or Decra
 Breather Membrane as
 appropriate

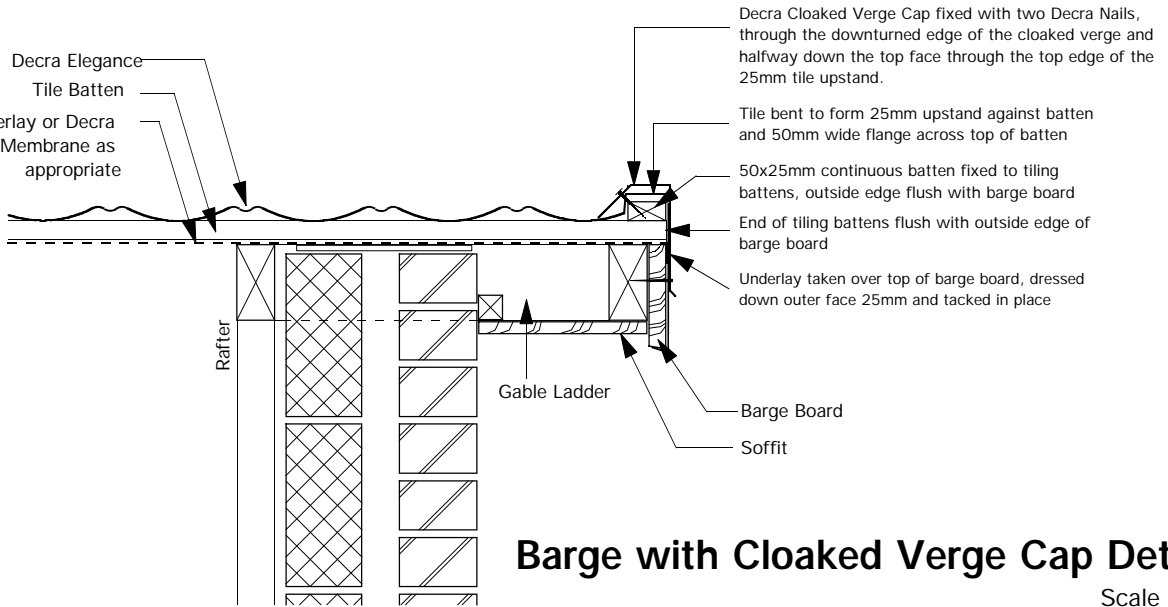

Decra Cloaked Verge Cap fixed with two Decra Nails, through the downturned edge of the cloaked verge and halfway down the top face through the top edge of the 25mm tile upstand.

Tile bent to form 25mm upstand against batten and 50mm wide flange across top of batten

50x25mm continuous batten fixed to tiling battens, outside edge flush with barge board

End of tiling battens flush with outside edge of barge board

Underlay taken over top of barge board, dressed down outer face 25mm and tacked in place

Rafter

Gable Ladder

Barge Board

Soffit

Barge with Cloaked Verge Cap Detail

Scale 1:10

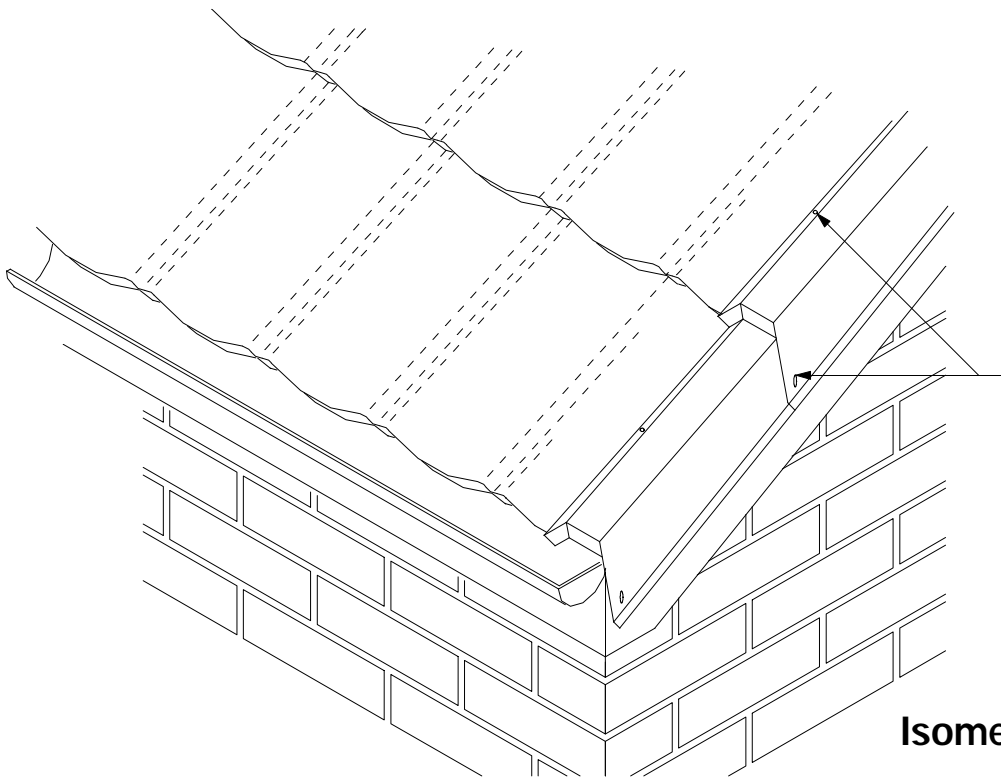

Decra Cloaked Verge Cap fixed with two Decra Nails, through the downturned edge of the cloaked verge and halfway down the top face through the top edge of the 25mm tile upstand.

Isometric Detail at Gutter

Scale 1:10

Notes:

Decra[®]
 Roof Systems Limited

A member of the Icopal Group



Unit 4
 Crompton Fields
 Crompton Way
 Crawley
 West Sussex
 RH10 9QB

telephone: (01293) 545058/9
 fax: (01293) 562709

email: technical@decra.co.uk
 web-Site: <http://www.decra.co.uk>

The copyright of this drawing and detail information belongs to Decra Roof Systems Limited. Reproduction or amendment outwith the terms of the licensing agreement by other parties is expressly forbidden.

DECRA ELEGANCE

CONTENT

**DECRA ELEGANCE
 CLOAKED VERGE CAP DETAIL**

DRAWING SCALE **1:10**

DATE **12/01/04**

DRAWING NO **DESE049**

REVISION

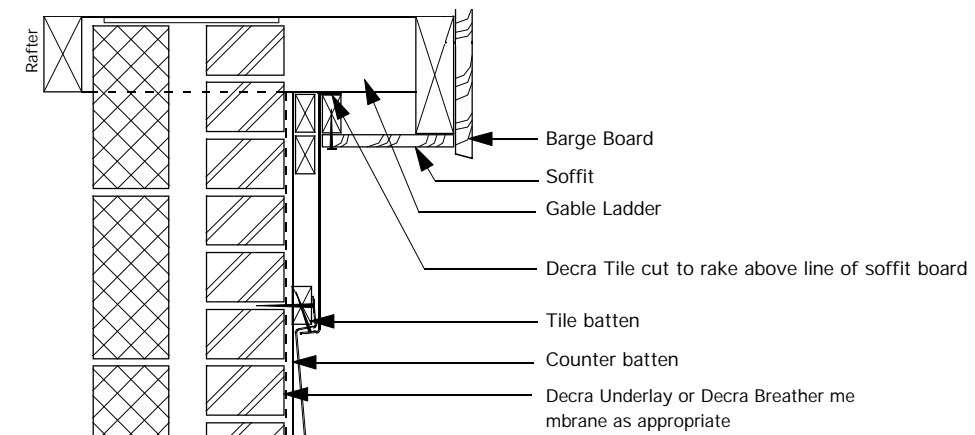

Vertical Tiles Detail

Scale 1:10

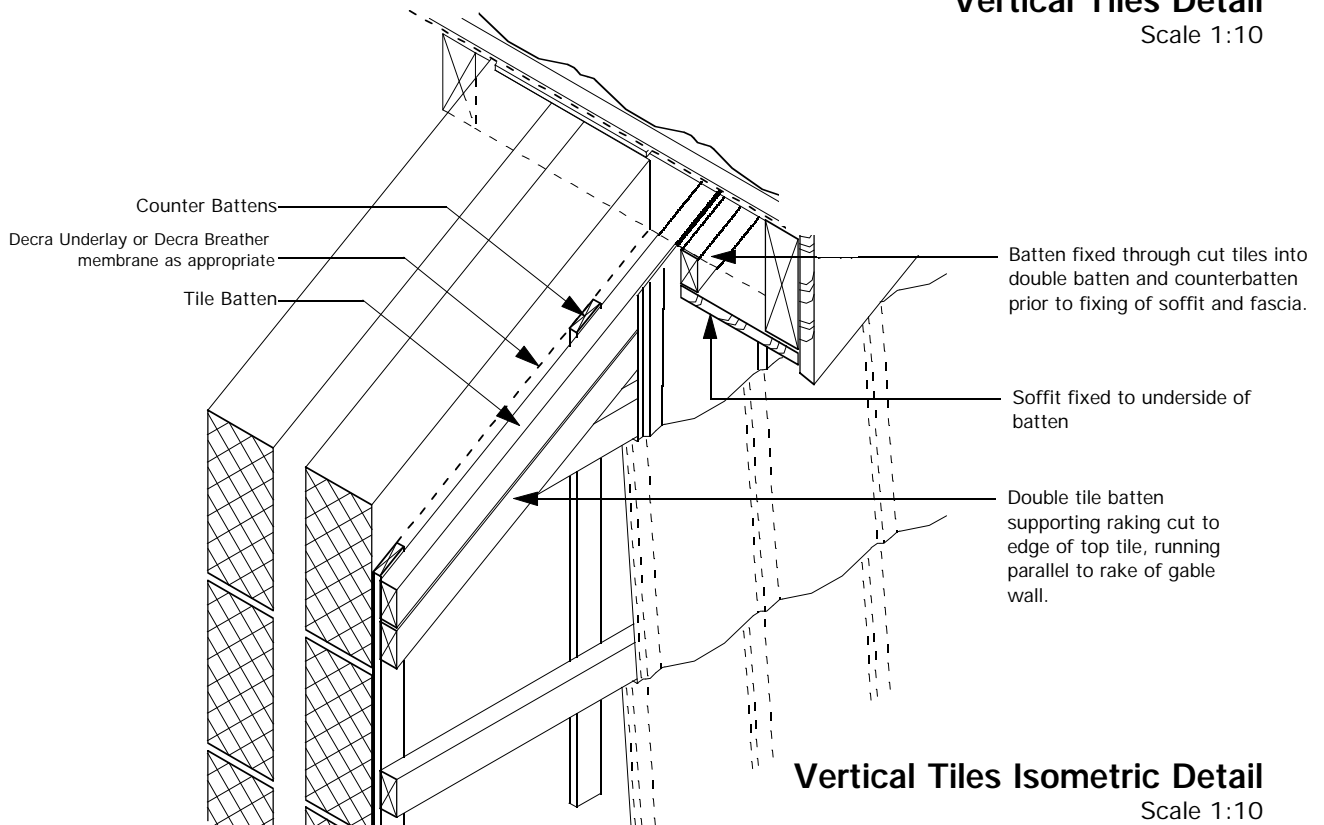

Vertical Tiles Isometric Detail

Scale 1:10

Notes:

Decra[®]
Roof Systems Limited

A member of the Icopal Group



Unit 4
Crompton Fields
Crompton Way
Crawley
West Sussex
RH10 9QB

telephone: (01293) 545058/9

fax: (01293) 562709

email: technical@decra.co.uk

web-Site: <http://www.decra.co.uk>

The copyright of this drawing and detail information belongs to Decra Roof Systems Limited. Reproduction or amendment outwith the terms of the licensing agreement by other parties is expressly forbidden.

DECRA ELEGANCE

CONTENT

DECRA ELEGANCE
VERTICAL TILING DETAIL

DRAWING SCALE

1:10

DATE

07/09/98

DRAWING NO

DESE051

REVISION

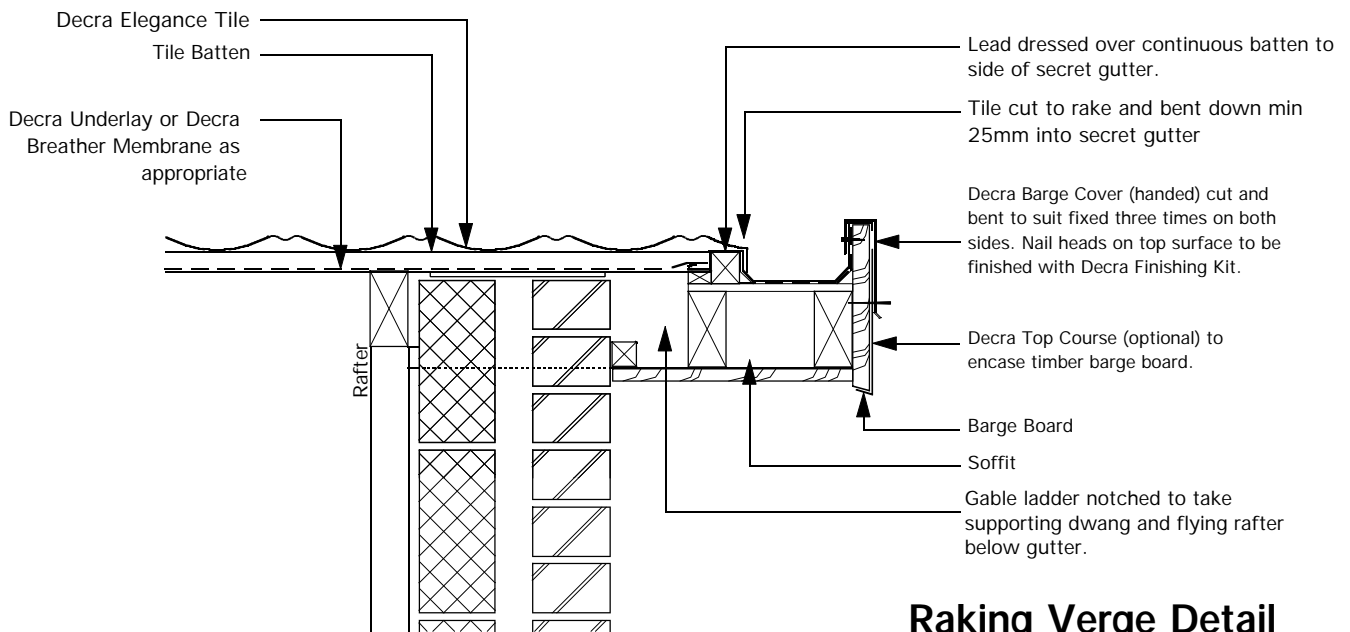

Raking Verge Detail
Scale 1:10

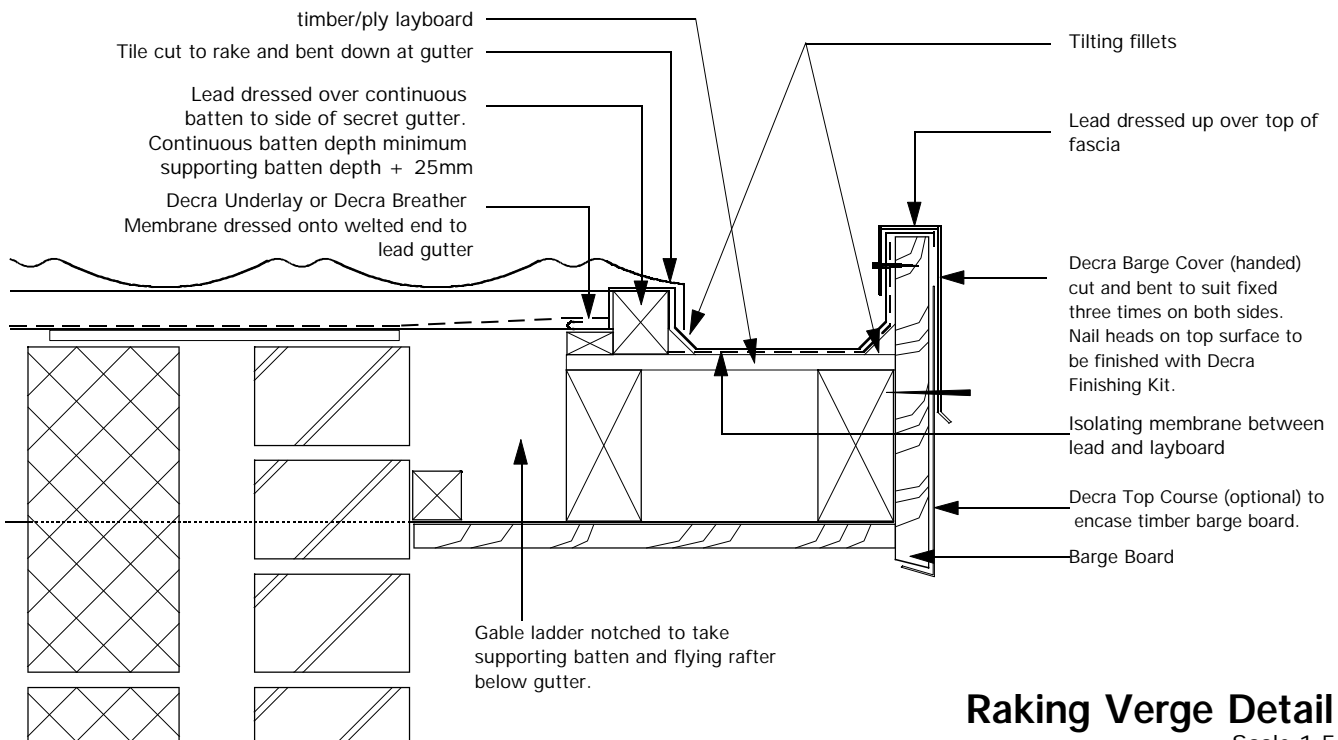

Raking Verge Detail
Scale 1:5

Notes:

*Gutter depth and width shown are indicative.
Valley gutter sizes to be adjusted as required to comply with calculated width requirements of Code Of Practice as set out in BS 5534: Part1 and BS 6367*

Decra®
Roof Systems Limited

A member of the Icopal Group



Unit 4
Crompton Fields
Crompton Way
Crawley
West Sussex
RH10 9QB

telephone: (01293) 545058/9
fax: (01293) 562709

email: technical@decra.co.uk
web-Site: <http://www.decra.co.uk>

The copyright of this drawing and detail information belongs to Decra Roof Systems Limited. Reproduction or amendment outwith the terms of the licensing agreement by other parties is expressly forbidden.

DECRA ELEGANCE

CONTENT
**DECRA ELEGANCE
RAKING VERGE - INTERNAL GUTTER**

DRAWING SCALE	1:10	DATE	07/02/01
DRAWING NO	DESE053	REVISION	

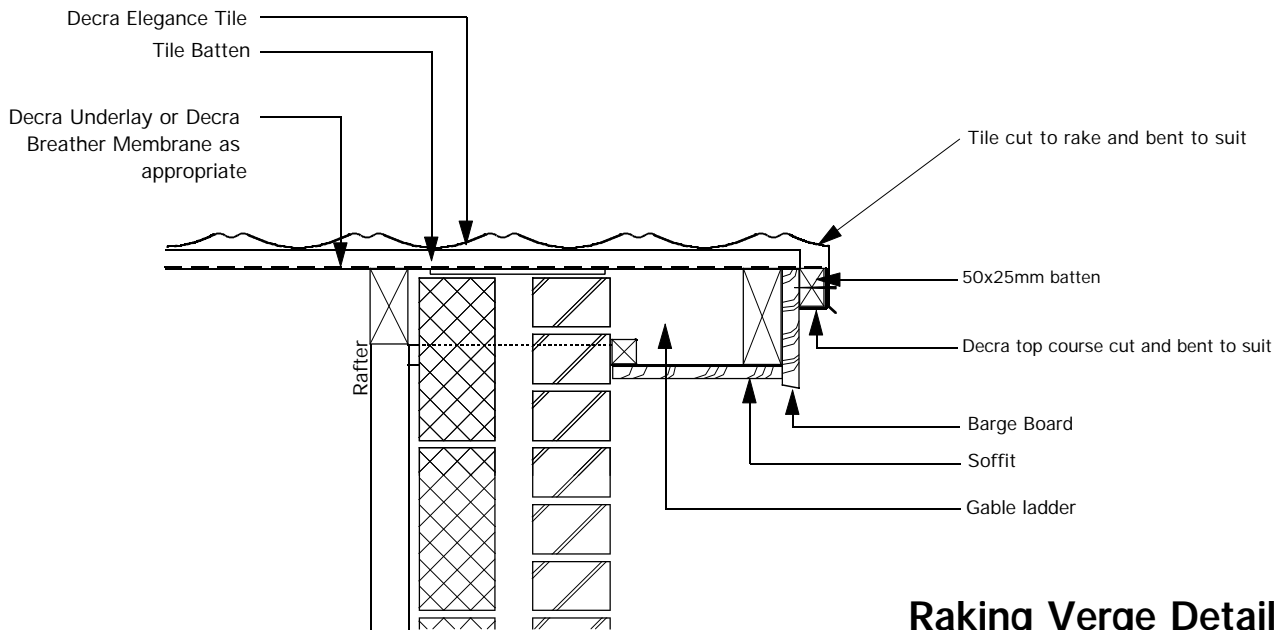

Raking Verge Detail
Scale 1:10

Notes:

Consideration should be given to the method of adequately draining rainwater run-off from the roof when using this detail. Where an external gutter is to be used the manufacturer's recommendations regarding minimum and maximum falls should be strictly adhered to.

Decra®
Roof Systems Limited
A member of the Icopal Group



Unit 4
Crompton Fields
Crompton Way
Crawley
West Sussex
RH10 9QB

telephone: (01293) 545058/9
fax: (01293) 562709
email: technical@decra.co.uk
web-Site: <http://www.decra.co.uk>

The copyright of this drawing and detail information belongs to Decra Roof Systems Limited. Reproduction or amendment outwith the terms of the licensing agreement by other parties is expressly forbidden.

DECRA ELEGANCE

CONTENT

**DECRA ELEGANCE
RAKING VERGE DETAIL**

DRAWING SCALE **1:10**

DATE **07/02/01**

DRAWING NO **DESE054**

REVISION

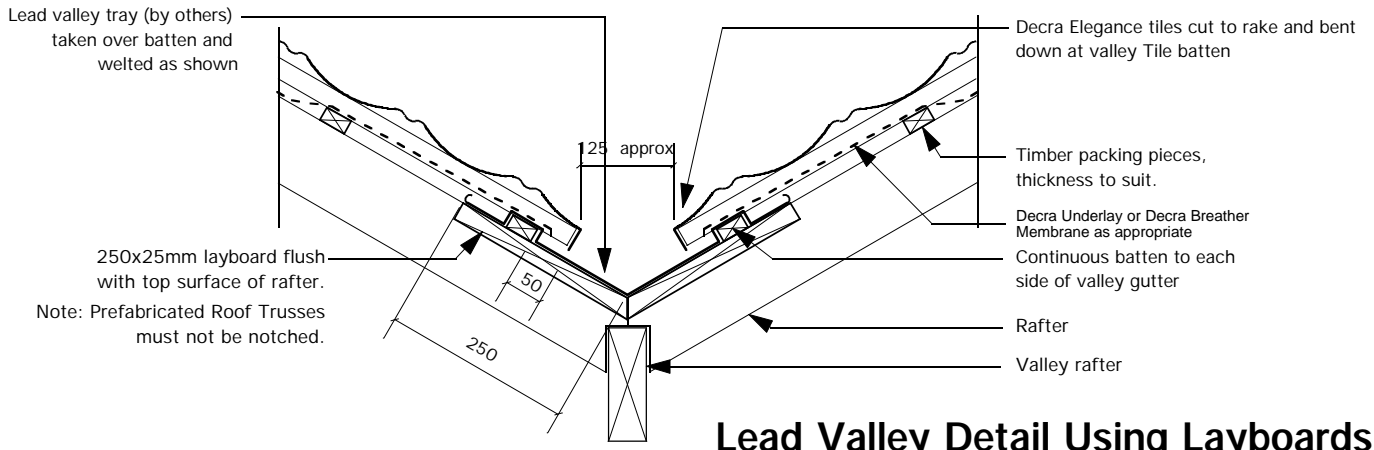

Lead Valley Detail Using Layboards
Scale 1:10

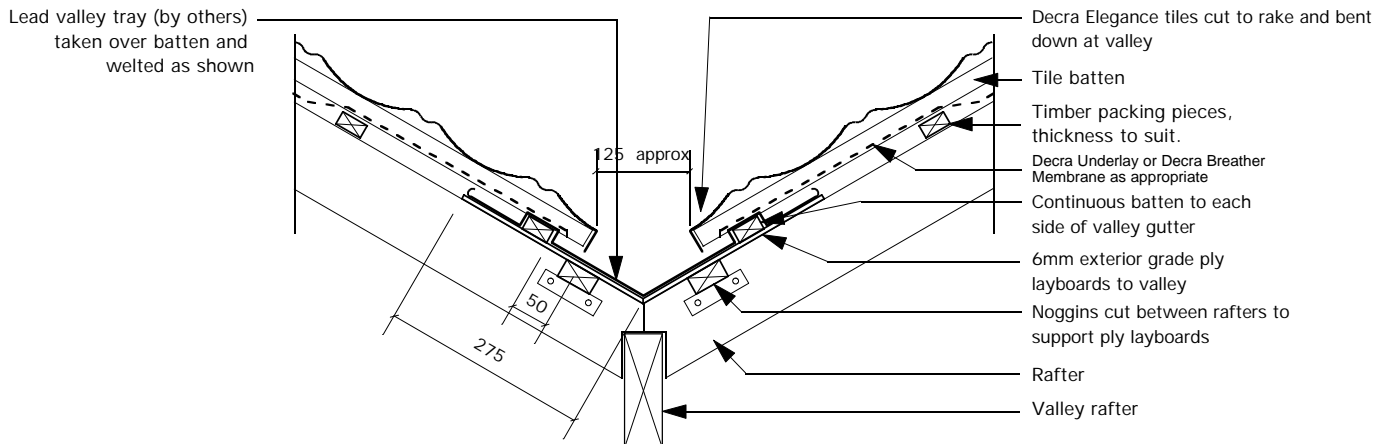

Lead Valley Detail Using Layboards Over Rafters
Scale 1:10

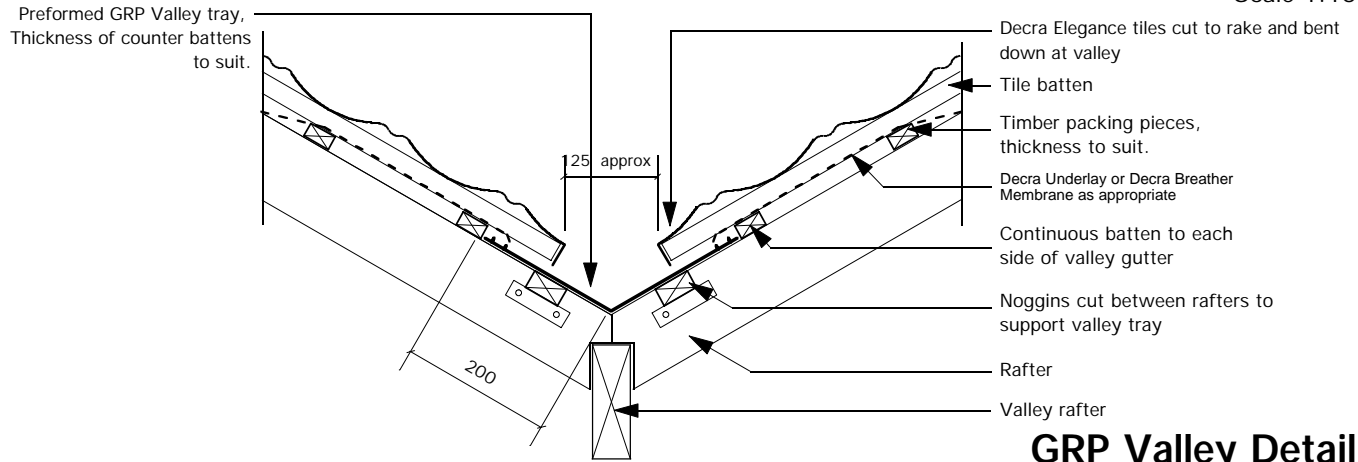

GRP Valley Detail
Scale 1:10

Notes:

Valley gutter sizes to be adjusted as required to comply with calculated width requirements of Code Of Practice as set out in BS 5534: Part1

The timber packing pieces are used to raise the tiling battens above the level of the rafters to create an upstand for the valley tray, and should be reduced from minimum 19mm thick across three or more rafters to avoid a visible rise in the tiling.

Decra[®]
Roof Systems Limited
A member of the Icopal Group



Unit 4
Crompton Fields
Crompton Way
Crawley
West Sussex
RH10 9QB

telephone: (01293) 545058/9
fax: (01293) 562709
email: technical@decra.co.uk
web-Site: <http://www.decra.co.uk>

DECRA ELEGANCE		
CONTENT	DECRA ELEGANCE VALLEY GUTTER DETAILS	
DRAWING SCALE	1:10	DATE 07/09/98
DRAWING NO	DESE055	REVISION

The copyright of this drawing and detail information belongs to Decra Roof Systems Limited. Reproduction or amendment outwith the terms of the licensing agreement by other parties is expressly forbidden.

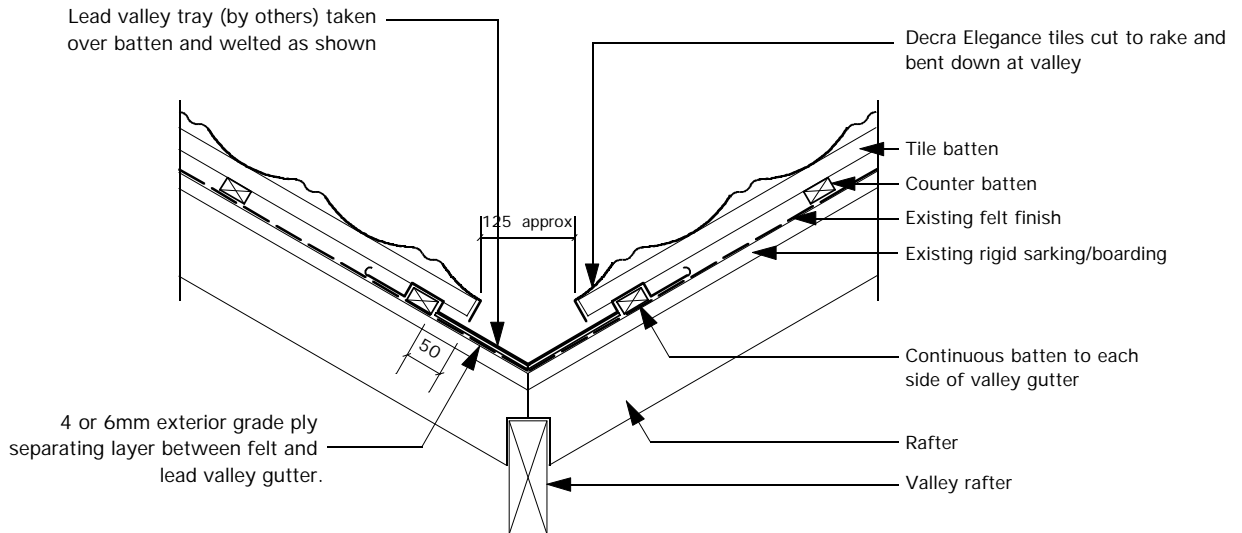

Lead Valley Detail On Felt or Boarded Roof

Scale 1:10

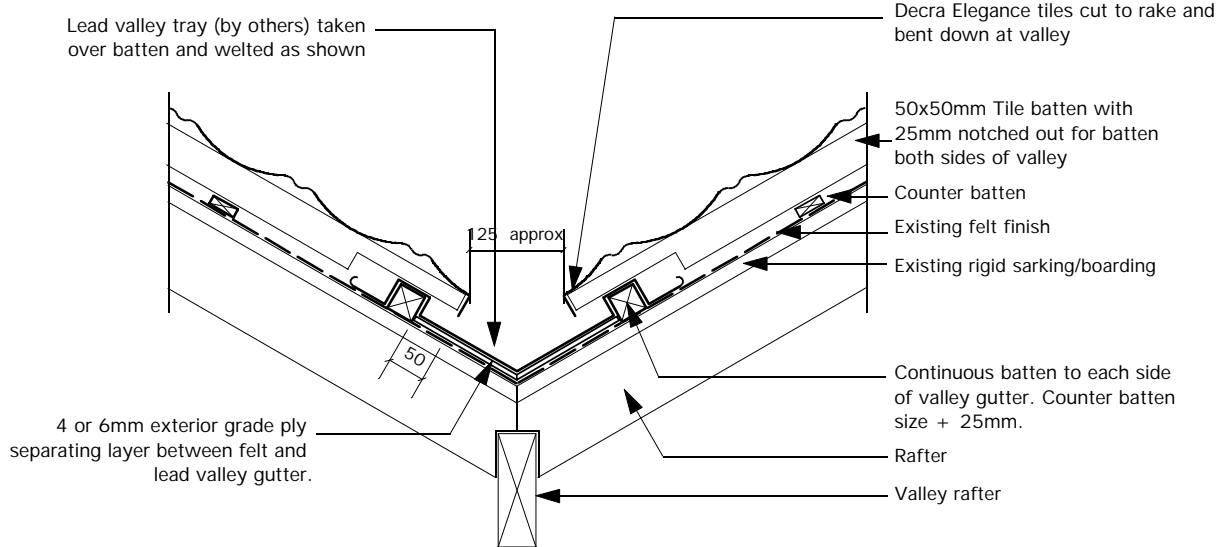

Lead Valley Detail using 50x50mm Tile Battens

Scale 1:10

Notes:

Valley gutter sizes to be adjusted as required to comply with calculated width requirements of Code Of Practice as set out in BS 5534: Part1

Decra®
Roof Systems Limited

A member of the Icopal Group



Unit 4
Crompton Fields
Crompton Way
Crawley
West Sussex
RH10 9QB

telephone: (01293) 545058/9
fax: (01293) 562709

email: technical@decra.co.uk
web-Site: <http://www.decra.co.uk>

The copyright of this drawing and detail information belongs to Decra Roof Systems Limited. Reproduction or amendment outwith the terms of the licensing agreement by other parties is expressly forbidden.

DECRA ELEGANCE

CONTENT

**DECRA ELEGANCE
VALLEY GUTTER DETAILS
TO FELTED/BOARDED ROOF**

DRAWING SCALE

1:10

DATE

07/09/98

DRAWING NO

DESE056

REVISION

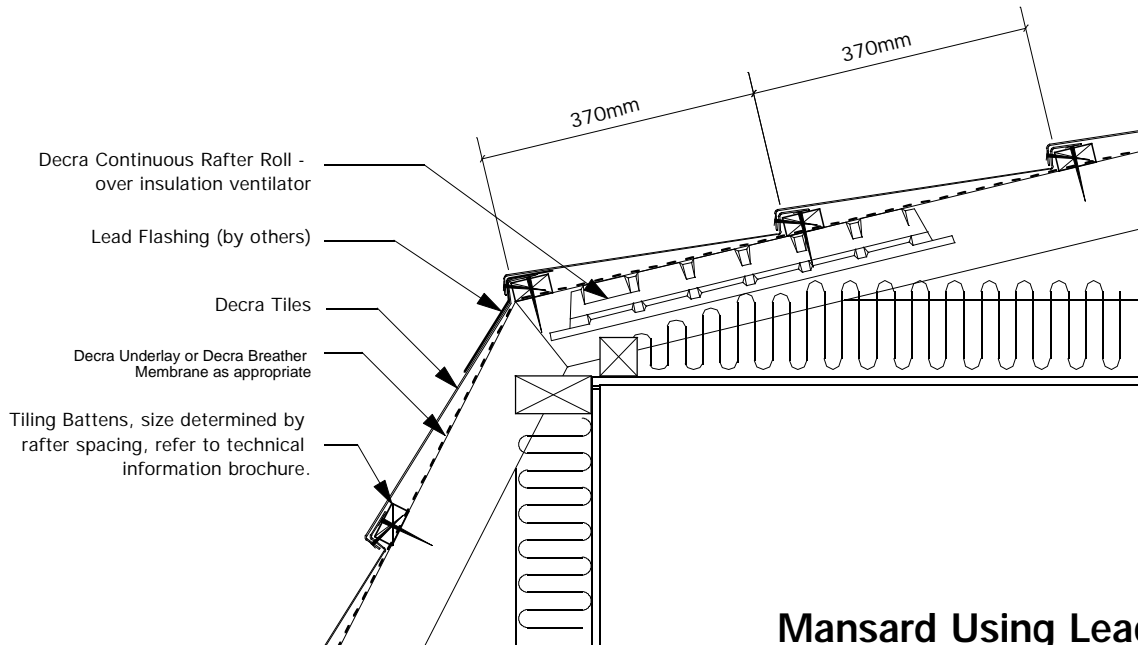

Mansard Using Lead Flashing

Scale 1:10

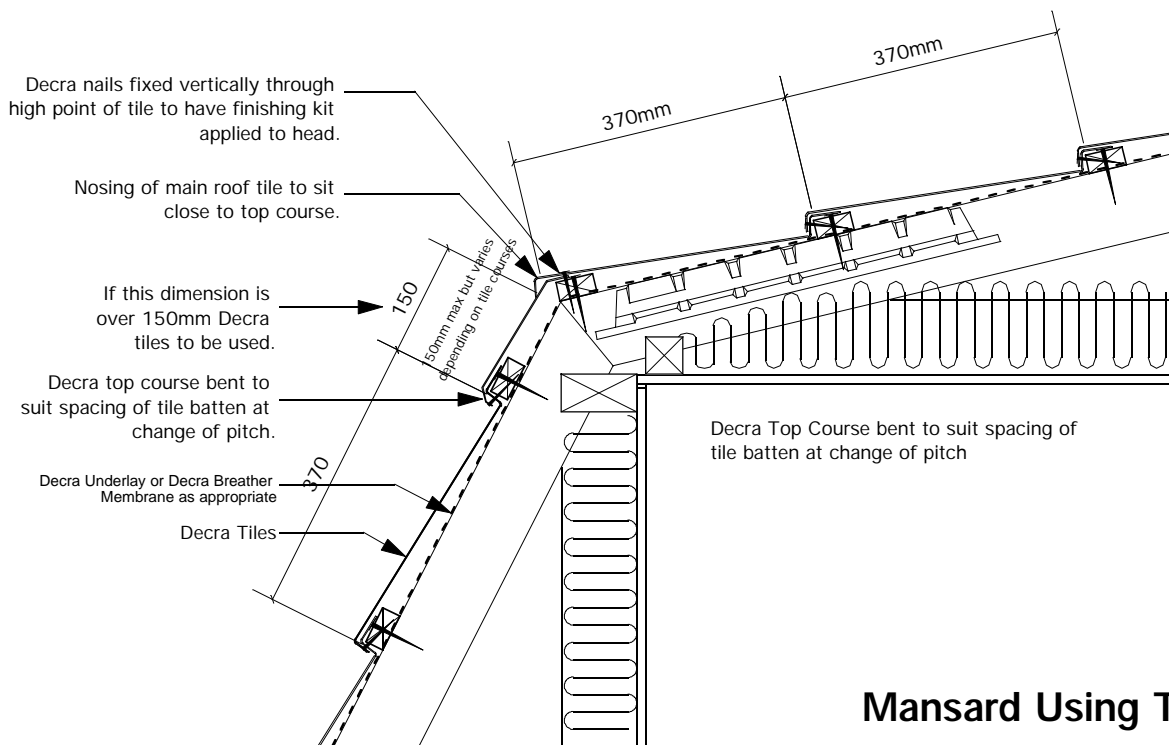

Mansard Using Top Course

Scale 1:10

Notes:

Decra[®]
Roof Systems Limited
A member of the Icopal Group



Unit 4
Crompton Fields
Crompton Way
Crawley
West Sussex
RH10 9QB

telephone: (01293) 545058/9
fax: (01293) 562709
email: technical@decra.co.uk
web-Site: <http://www.decra.co.uk>

The copyright of this drawing and detail information belongs to Decra Roof Systems Limited. Reproduction or amendment outwith the terms of the licensing agreement by other parties is expressly forbidden.

DECRA ELEGANCE		
CONTENT	DECRA ELEGANCE MANSARD ROOF DETAILS	
DRAWING SCALE	1:10	DATE 07/09/98
DRAWING NO	DESE060	REVISION

Note:
Flue diameter and thickness of brickwork to comply with building regulations requirements. Thicknesses shown are indicative

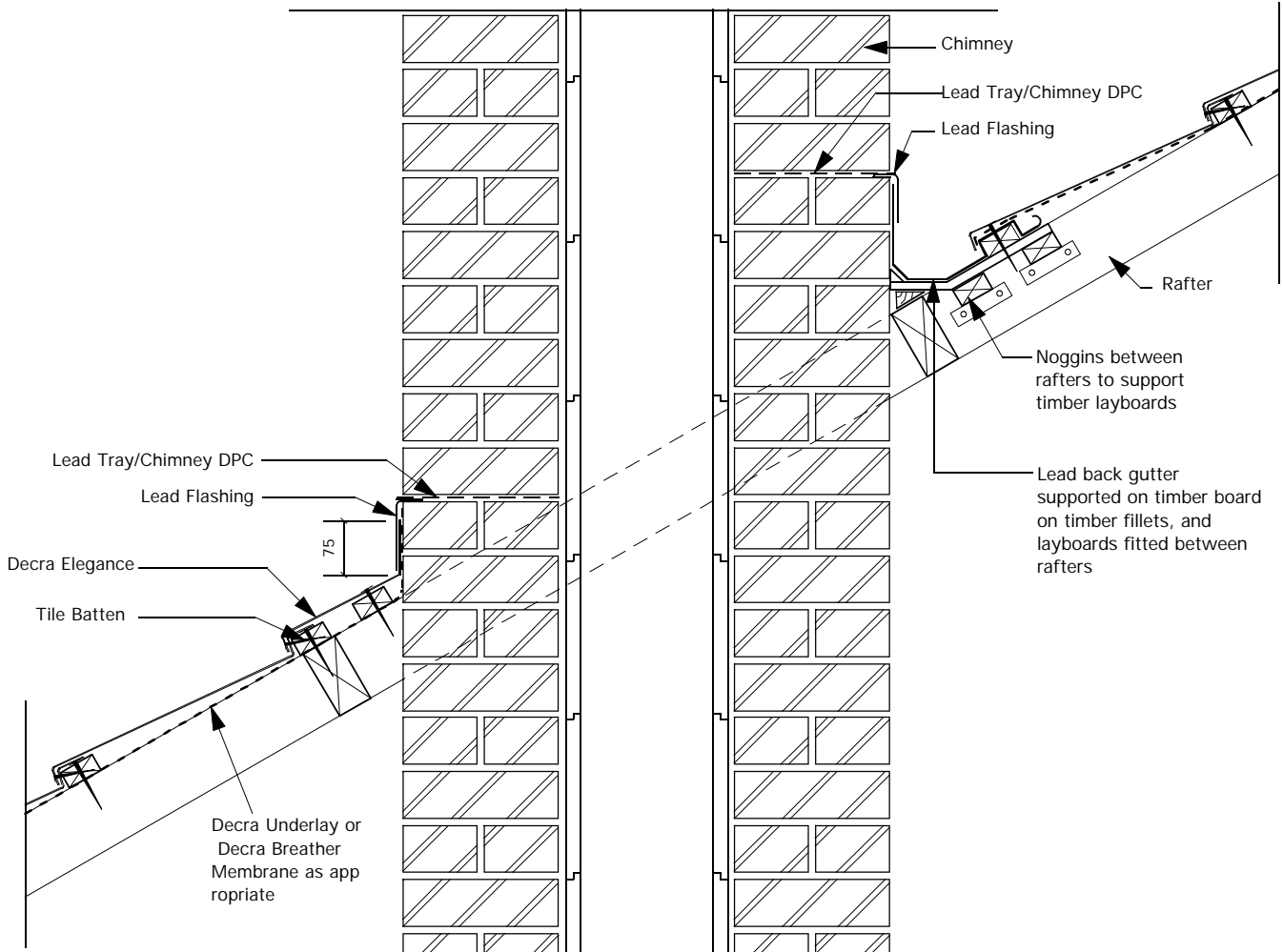

Flashing Details to Chimney

Scale 1:10

Notes:

Decra[®]
Roof Systems Limited

A member of the Icopal Group



Unit 4
Crompton Fields
Crompton Way
Crawley
West Sussex
RH10 9QB

telephone: (01293) 545058/9

fax: (01293) 562709

email: technical@decra.co.uk

web-Site: <http://www.decra.co.uk>

The copyright of this drawing and detail information belongs to Decra Roof Systems Limited. Reproduction or amendment outwith the terms of the licensing agreement by other parties is expressly forbidden.

DECRA ELEGANCE

CONTENT

DECRA ELEGANCE
FLASHING DETAILS TO CHIMNEY

DRAWING SCALE

1:10

DATE

07/09/98

DRAWING NO

DESE061

REVISION

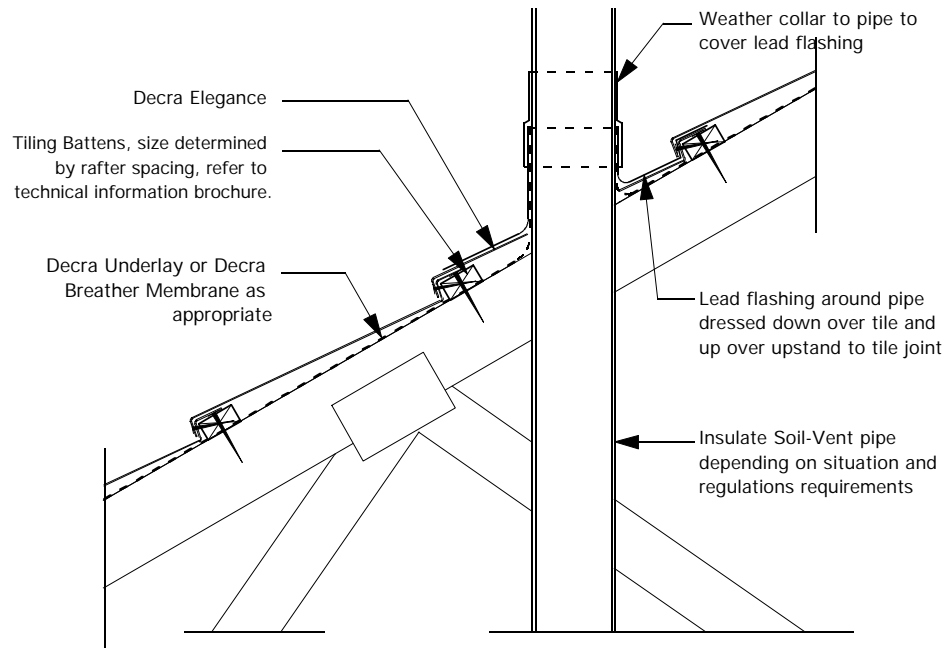

Soil Vent Pipe Through Roof
Scale 1:10

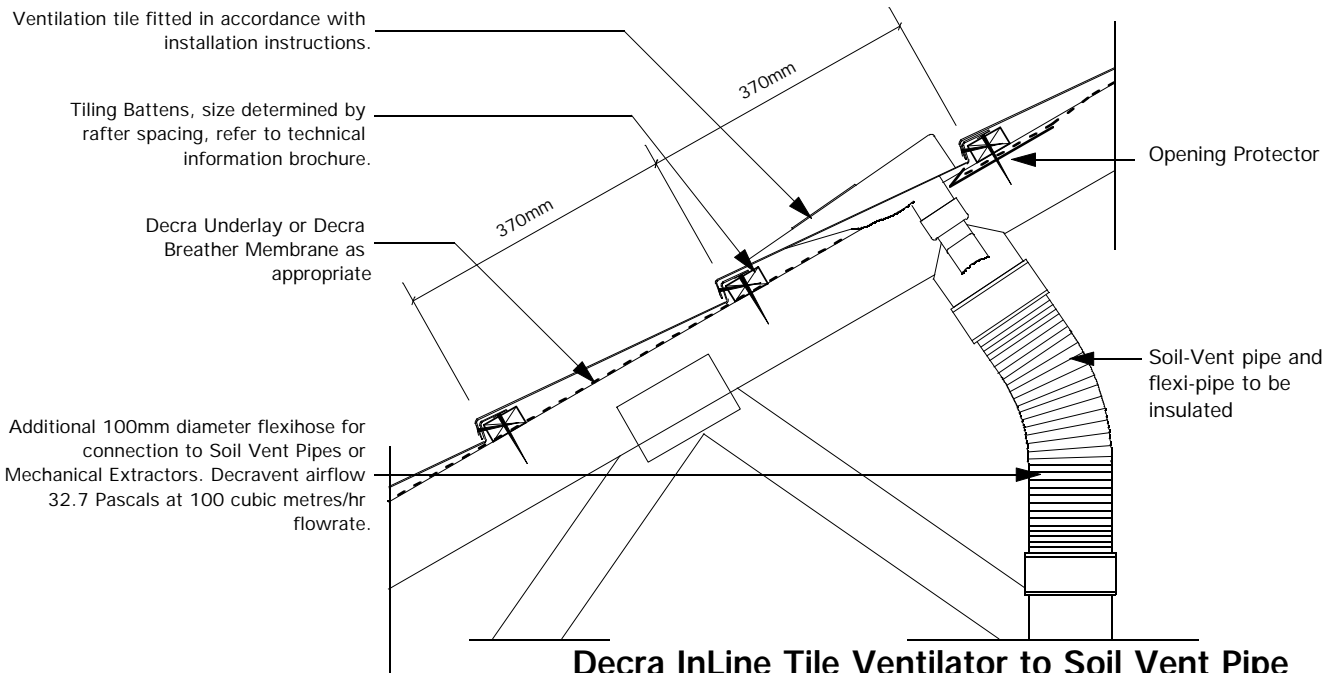

Decra InLine Tile Ventilator to Soil Vent Pipe
Scale 1:10

Notes:

Decra[®]
Roof Systems Limited
A member of the Icopal Group



Unit 4
Crompton Fields
Crompton Way
Crawley
West Sussex
RH10 9QB

telephone: (01293) 545058/9
fax: (01293) 562709
email: technical@decra.co.uk
web-Site: <http://www.decra.co.uk>

DECRA ELEGANCE

**DECRA ELEGANCE
SOIL VENT TERMINAL DETAILS**

CONTENT	DECRA ELEGANCE SOIL VENT TERMINAL DETAILS	
DRAWING SCALE	1:10	DATE 07/09/98
DRAWING NO	DESE062	REVISION

The copyright of this drawing and detail information belongs to Decra Roof Systems Limited. Reproduction or amendment outwith the terms of the licensing agreement by other parties is expressly forbidden.

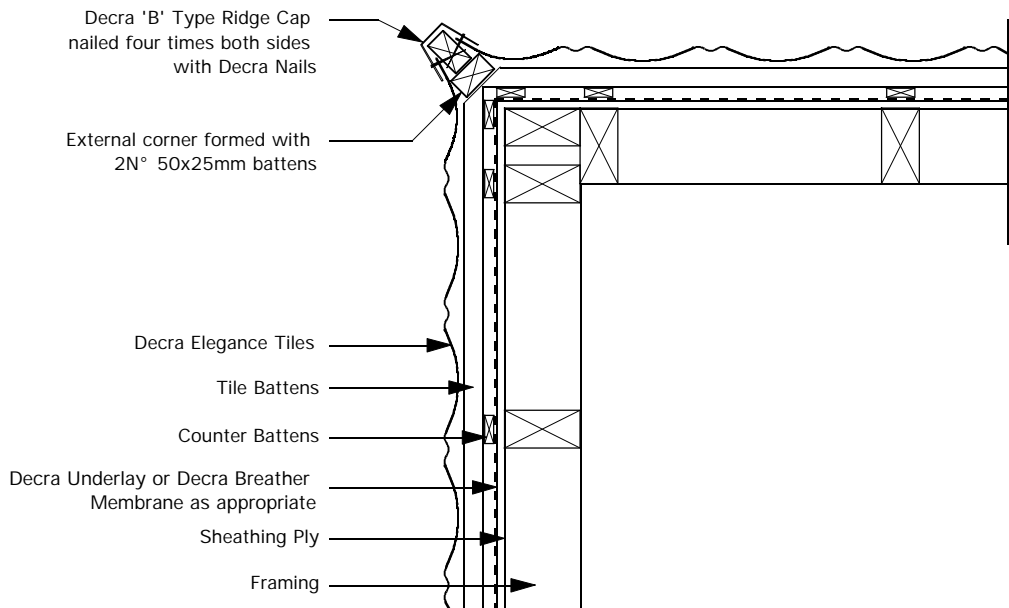

**Detail of External Corner
Using Decra 'B' Ridge**
Scale 1:10

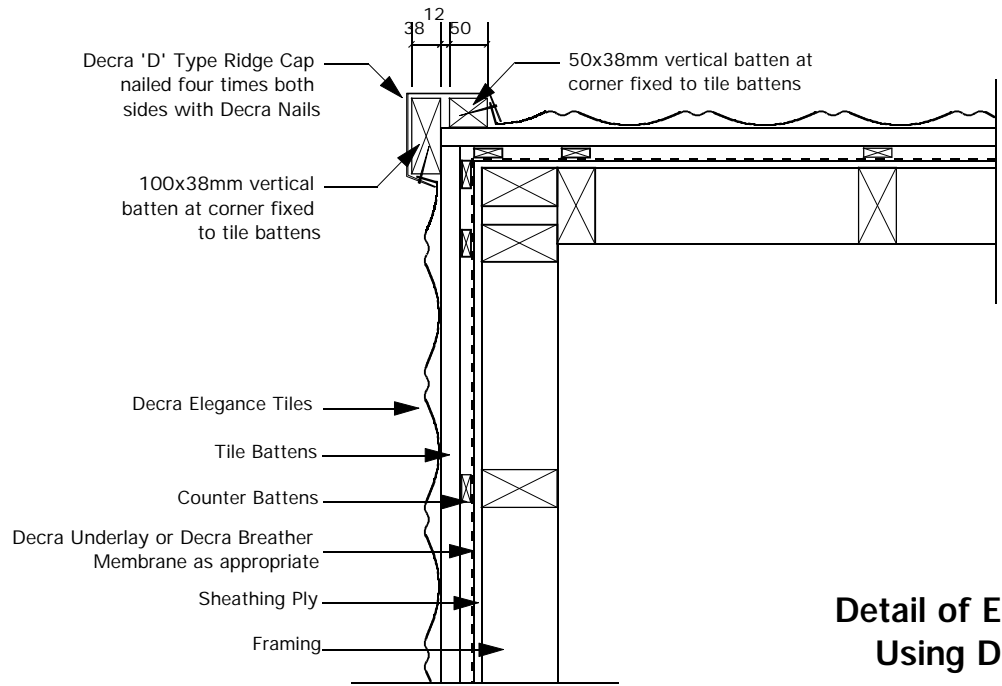

**Detail of External Corner
Using Decra 'D' Ridge**
Scale 1:10

Notes:

Decra®
Roof Systems Limited
A member of the Icopal Group



Unit 4
Crompton Fields
Crompton Way
Crawley
West Sussex
RH10 9QB

telephone: (01293) 545058/9
fax: (01293) 562709
email: technical@decra.co.uk
web-Site: <http://www.decra.co.uk>

The copyright of this drawing and detail information belongs to Decra Roof Systems Limited. Reproduction or amendment outwith the terms of the licensing agreement by other parties is expressly forbidden.

DECRA ELEGANCE		
DECRA ELEGANCE VERTICAL CORNER DETAILS		
DRAWING SCALE	1:10	DATE 07/09/98
DRAWING NO	DESE064	REVISION

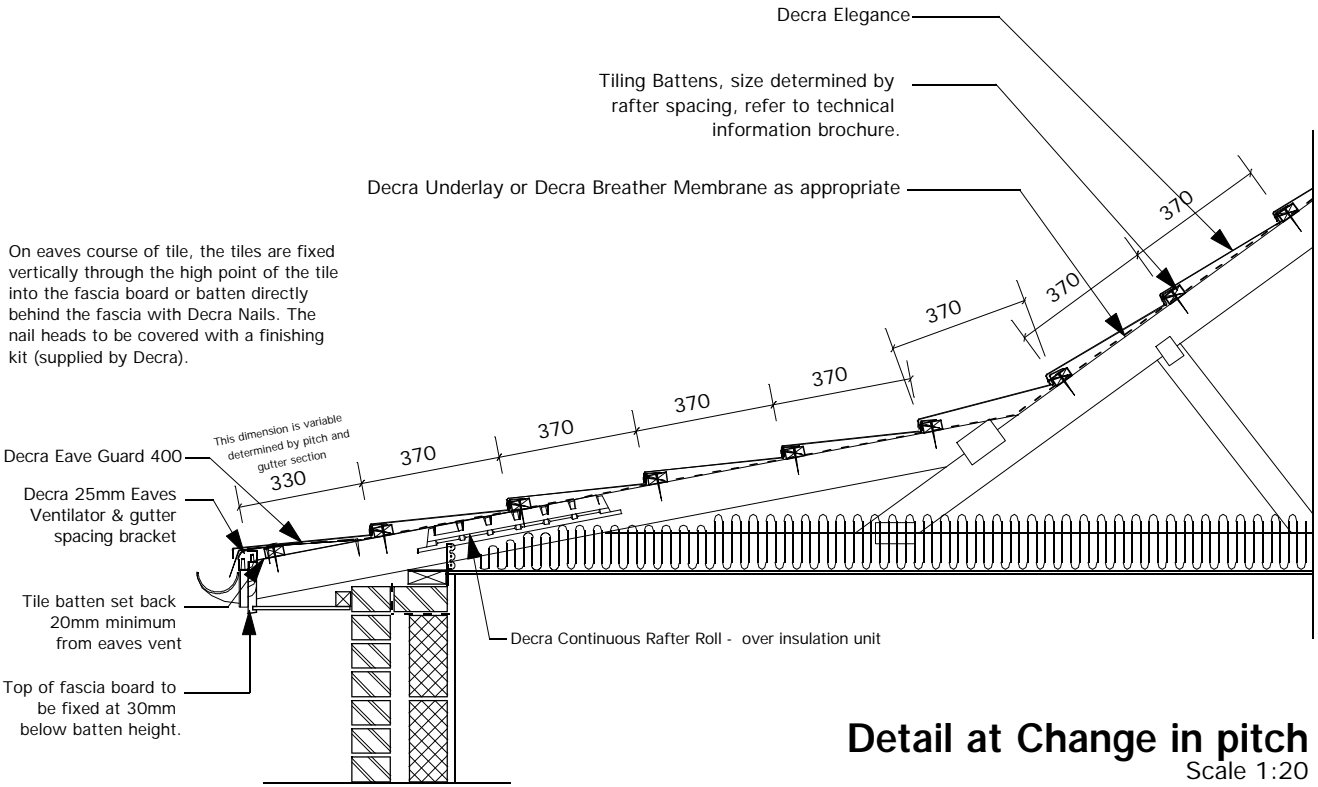

Detail at Change in pitch
Scale 1:20

Note:
If eaves ventilation is to be used, fascia board is to be fixed at 15mm below batten height for 10mm over fascia ventilator and 25mm below for 25mm over fascia ventilator. Sarking board to be cut back to allow clear ventilation when using over fascia vents.
Note: the 10mm over fascia ventilator cannot be used with roof pitches below 15°

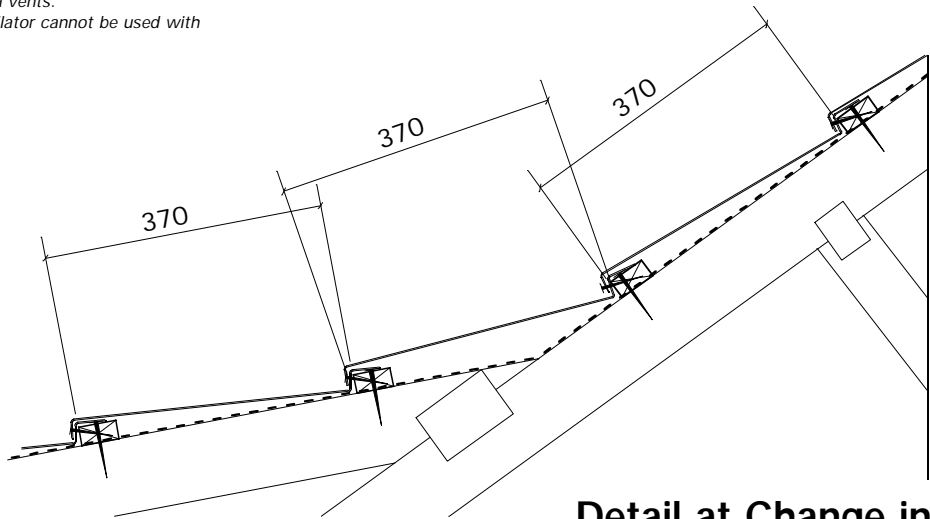

Detail at Change in pitch
Scale 1:10

Notes:
Refer also to detail drawings DESE015, DESE016, DESE017 and DESE 018 for Decra Eave Gaurd and Decra Fascia Vent combinations. Note that the 10mm fascia vent cannot be used at roof pitches below 15°, the 25mm fascia vent should be used instead - see also the ventilation recommendations in the information section of the Decra Technical Services CD.

Decra®
Roof Systems Limited
A member of the Icopal Group



Unit 4
Crompton Fields
Crompton Way
Crawley
West Sussex
RH10 9QB

telephone: (01293) 545058/9
fax: (01293) 562709
email: technical@decra.co.uk
web-Site: <http://www.decra.co.uk>

DECRA ELEGANCE		
CONTENT DETAIL AT CHANGE IN ROOF PITCH USING DECRA EAVE GUARD 400 AND 25MM VENTILATOR		
DRAWING SCALE	1:10/20	DATE 21/04/03
DRAWING NO	DESE065	REVISION

The copyright of this drawing and detail information belongs to Decra Roof Systems Limited. Reproduction or amendment outwith the terms of the licensing agreement by other parties is expressly forbidden.

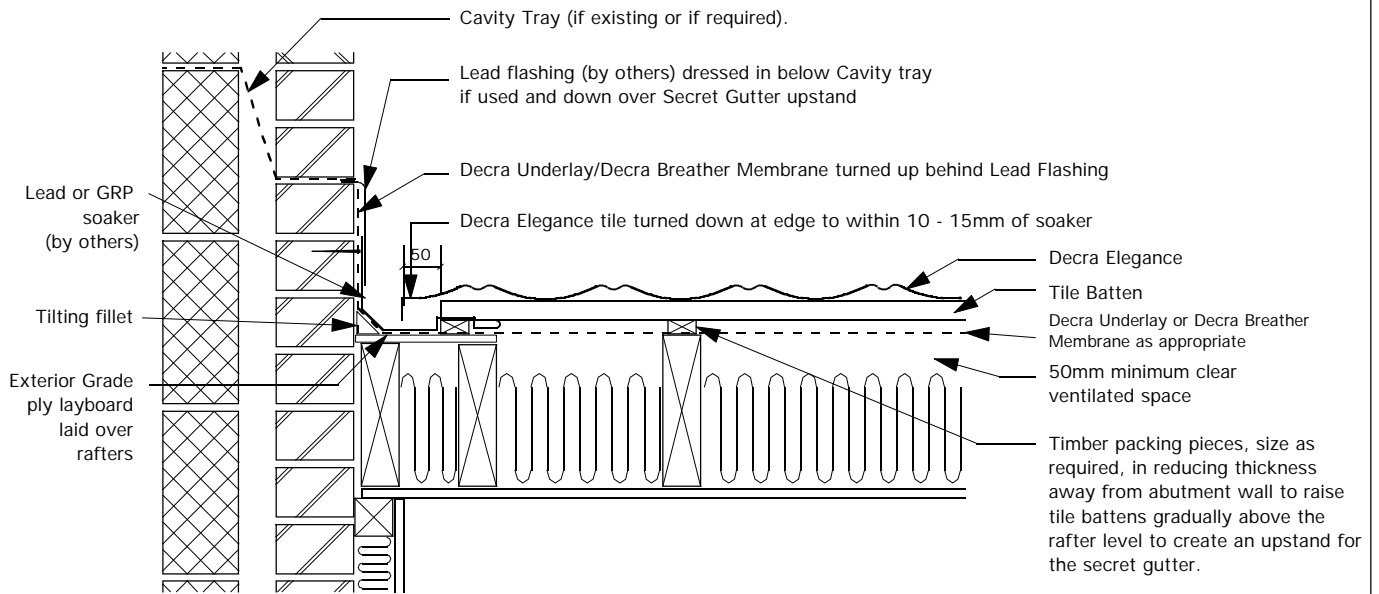

Abutment Detail With Secret Gutter
Scale 1:10

Notes:

Abutment Detail with Secret Gutter suitable only for roofs of pitch 25° or greater.

Decra®
Roof Systems Limited
A member of the Icopal Group



Unit 4
Crompton Fields
Crompton Way
Crawley
West Sussex
RH10 9QB

telephone: (01293) 545058/9
fax: (01293) 562709
email: technical@decra.co.uk
web-Site: <http://www.decra.co.uk>

The copyright of this drawing and detail information belongs to Decra Roof Systems Limited. Reproduction or amendment outwith the terms of the licensing agreement by other parties is expressly forbidden.

DECRA ELEGANCE

CONTENT		
DECRA ELEGANCE ABUTMENT DETAIL WITH SECRET GUTTER		
DRAWING SCALE	1:10	DATE 07/09/98
DRAWING NO	DESE070	REVISION

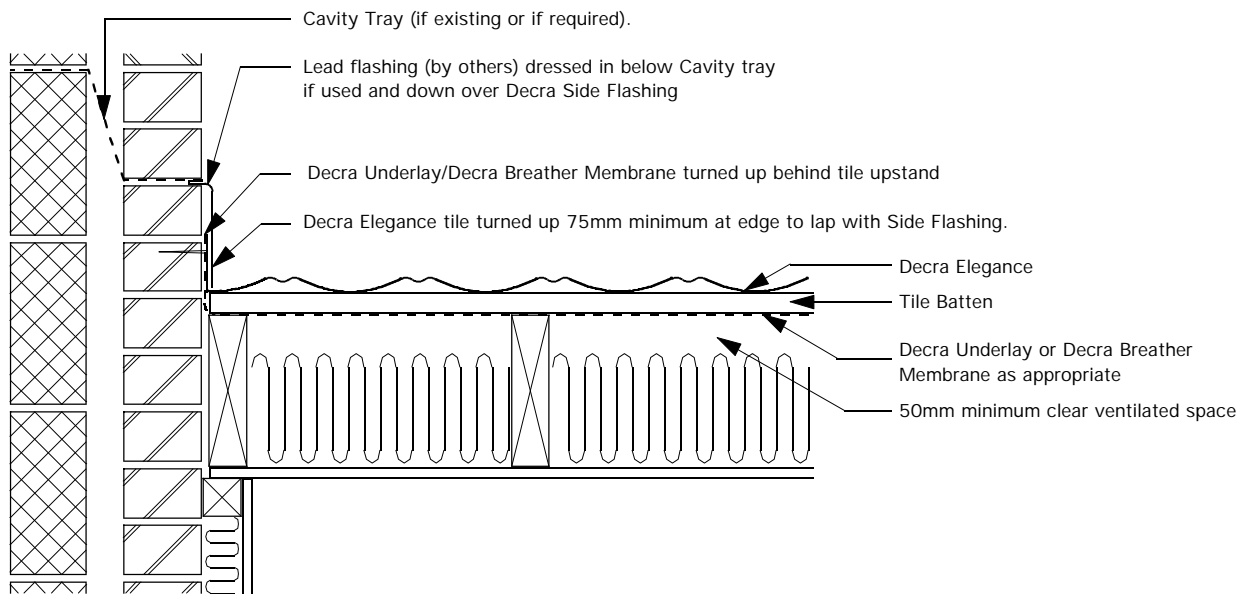

Abutment Detail Without Side Flashing

Scale 1:10

Notes:

Decra[®]
Roof Systems Limited

A member of the Icopal Group



Unit 4
Crompton Fields
Crompton Way
Crawley
West Sussex
RH10 9QB

telephone: (01293) 545058/9

fax: (01293) 562709

email: technical@decra.co.uk

web-Site: <http://www.decra.co.uk>

The copyright of this drawing and detail information belongs to Decra Roof Systems Limited. Reproduction or amendment outwith the terms of the licensing agreement by other parties is expressly forbidden.

DECRA ELEGANCE

CONTENT

**DECRA ELEGANCE
ABUTMENT DETAILS**

DRAWING SCALE

1:10

DATE

07/09/98

DRAWING NO

DESE071

REVISION

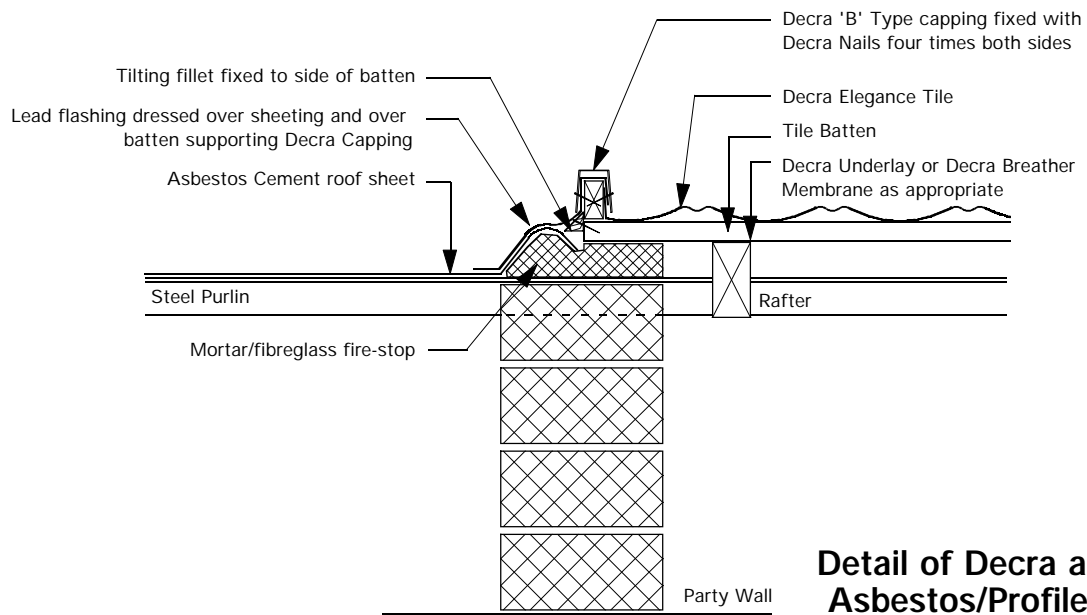

**Detail of Decra abutting
Asbestos/Profiled Sheet**

Scale 1:10

Notes:

Decra[®]
Roof Systems Limited

A member of the Icopal Group



Unit 4
Crompton Fields
Crompton Way
Crawley
West Sussex
RH10 9QB

telephone: (01293) 545058/9
fax: (01293) 562709

email: technical@decra.co.uk
web-Site: <http://www.decra.co.uk>

The copyright of this drawing and detail information belongs to Decra Roof Systems Limited. Reproduction or amendment outwith the terms of the licensing agreement by other parties is expressly forbidden.

DECRA ELEGANCE

CONTENT

**DECRA ELEGANCE
ROOF SHEETING ABUTMENT DETAILS**

DRAWING SCALE **1:10**

DATE **07/09/98**

DRAWING NO **DESE072**

REVISION

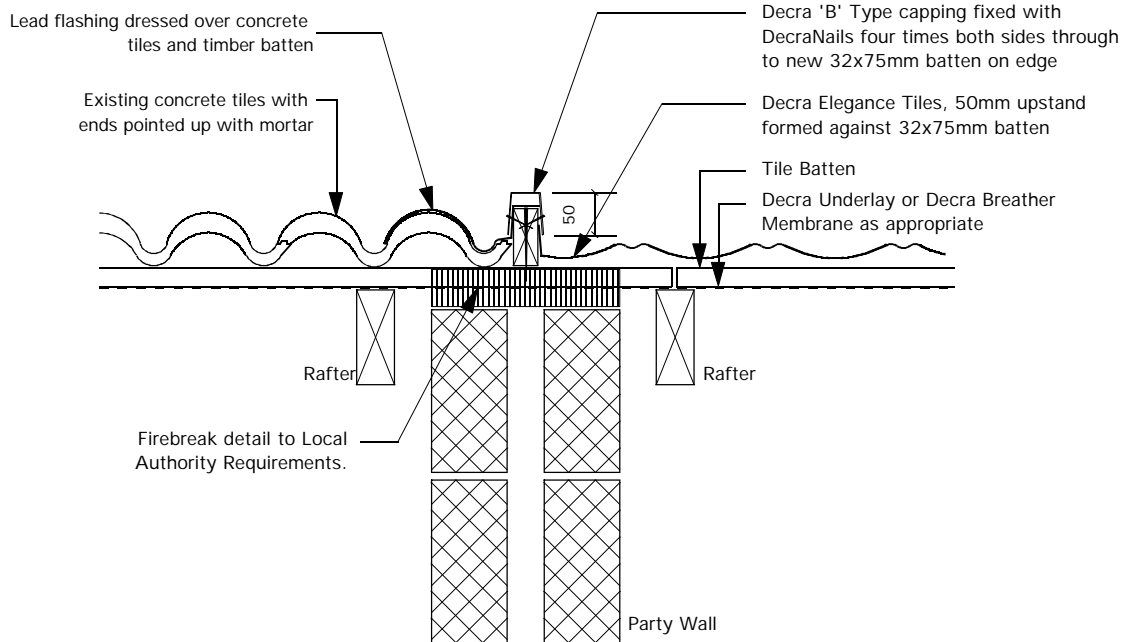

**Detail of Decra abutting
Concrete Tiles of Profiled Section**

Scale 1:10

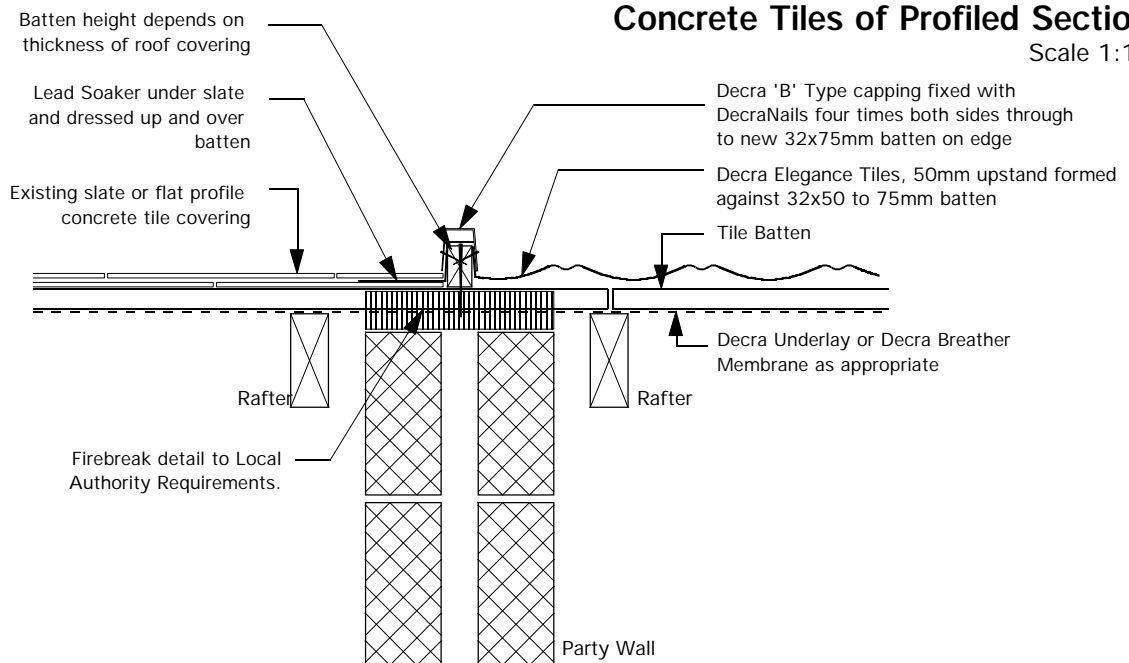

**Detail of Decra abutting
Slate or flat profile Concrete Tile**

Scale 1:10

Notes:

Decra[®]
Roof Systems Limited

A member of the Icopal Group



Unit 4
Crompton Fields
Crompton Way
Crawley
West Sussex
RH10 9QB

telephone: (01293) 545058/9

fax: (01293) 562709

email: technical@decra.co.uk

web-Site: <http://www.decra.co.uk>

The copyright of this drawing and detail information belongs to Decra Roof Systems Limited. Reproduction or amendment outwith the terms of the licensing agreement by other parties is expressly forbidden.

DECRA ELEGANCE

CONTENT

**DECRA ELEGANCE
SLATE AND TILE ABUTMENT DETAILS**

DRAWING SCALE **1:10**

DATE **07/09/98**

DRAWING NO **DESE073**

REVISION

VELUX - EDW FLASHING

Note:
50x25mm battens:
6mm ply layboards to be fitted to top edge and sides to secure Velux brackets at 20mm below top surface of tiling battens.

50x50 and 50x38mm Battens:
Tiling battens to be notched 20mm to secure Velux fixing brackets 20mm below top surface of tiling battens.

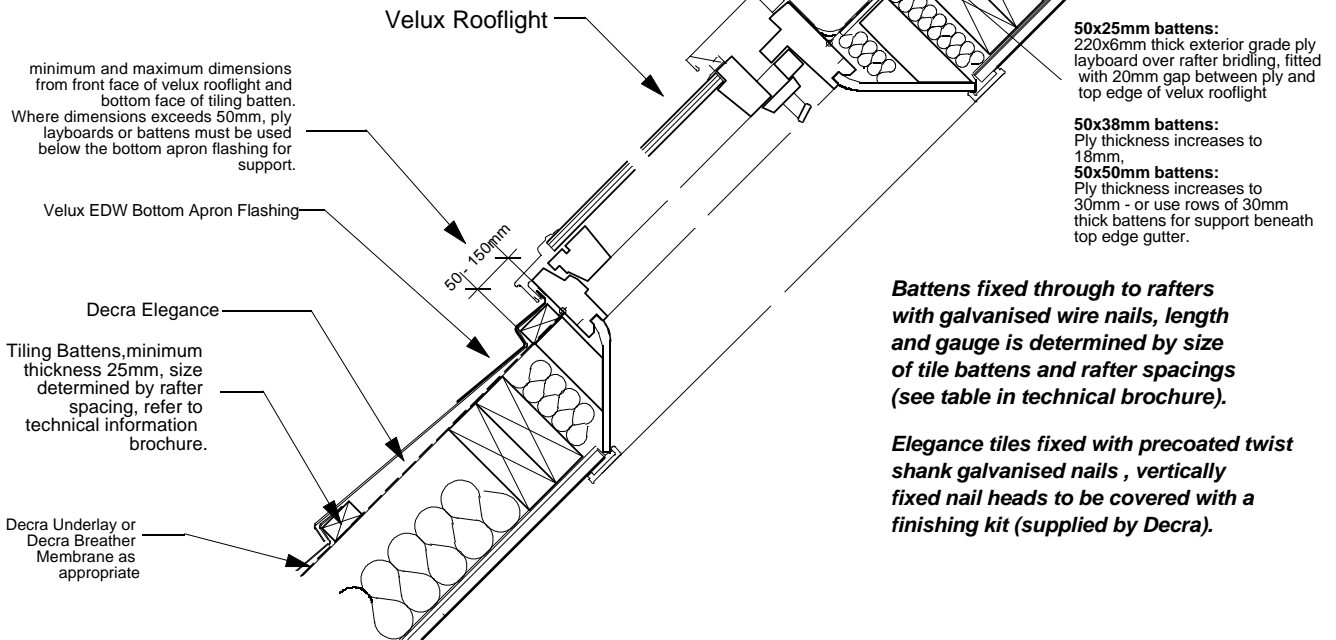

Battens fixed through to rafters with galvanised wire nails, length and gauge is determined by size of tile battens and rafter spacings (see table in technical brochure).

Elegance tiles fixed with pre-coated twist shank galvanised nails, vertically fixed nail heads to be covered with a finishing kit (supplied by Decra).

Typical Section Scale 1:10

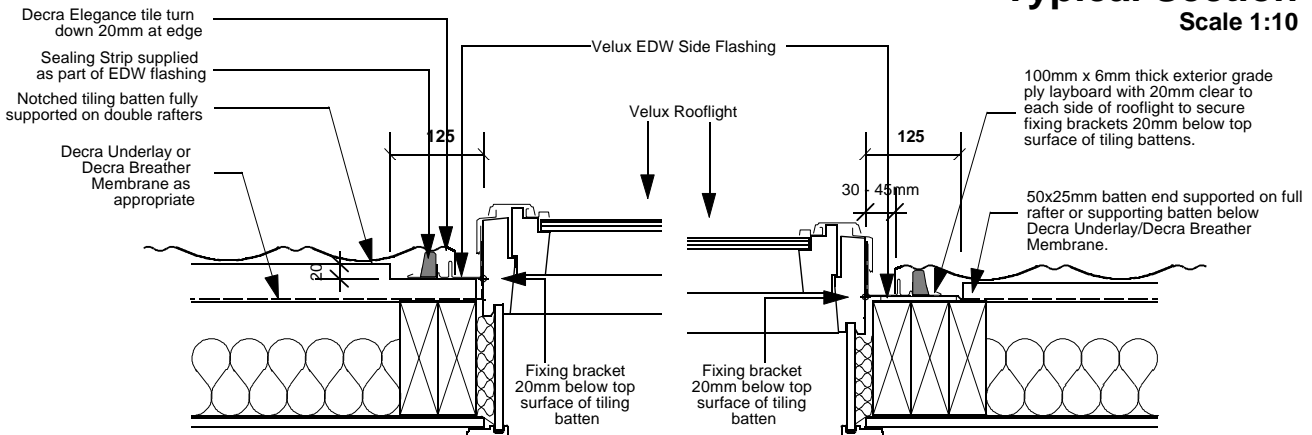

Detail using 50x50mm Battens

This detail same for 50x38mm battens, battens notched 20mm to secure fixing brackets 20mm below line of tiling battens

Detail using 50x25mm Battens

Typical Cross-Sections Scale 1:10

Notes:

15° minimum roof pitch for Velux GGL Rooflights.

Velux Type EDW flashings must be used

The use of the following rooflights are to be strongly recommended for improved fitting in conjunction with Decra Elegance tile: GGL206, GGL306, GGL410, GGL606, Special sizes complying with overall external frame heights of 1180mmx1600mm.

Velux Rooflight profiles and details courtesy of, and copyright to, Velux.

This detail is to be read in conjunction with Velux installation and design instructions.

Design and installation must ensure that ventilation of roofspace requirements are adhered to. Detail shown may not suit all types of roof construction where ventilation is concerned.

This detail to be read in conjunction with Acrobat files for velux installation instructions in the information section on the Decra Technical Services CD

Decra®
Roof Systems Limited

A member of the Icopal Group



Unit 4
Crompton Fields
Crompton Way
Crawley
West Sussex
RH10 9QB

telephone: (01293) 545058/9
fax: (01293) 562709
email: technical@decra.co.uk
web-Site: <http://www.decra.co.uk>

The copyright of this drawing and detail information belongs to Decra Roof Systems Limited. Reproduction or amendment outwith the terms of the licensing agreement by other parties is expressly forbidden.

DECRA ELEGANCE

CONTENT

**DECRA ELEGANCE
VELUX ROOFLIGHT EDW FLASHING**

DRAWING SCALE **1:10**

DATE **07/09/98**

DRAWING NO **DESE080**

REVISION