

Decra Stratos Tile

Installation Instructions (March 2015)

Decra®
Roof Systems



Our Contact Details

If there is anything in this guide that you do not understand or that is unclear to you please do not hesitate to contact us on;

Tel: 0161 8654444

Fax: 0161 8642616

Web: www.decra.co.uk

Email: technical@decra.co.uk

1. Safety

These instructions are illustrative only. For the sake of clarity, access equipment, which should always be erected in accordance with safety regulations, has been omitted, as have safety helmets, roofing felt and sarking boards.

2. You Need

Pencil.

Tape measure or ruler.

Tin snips.

Decra hand nails, Decra Power Nails* or Decra Screws.

i You must only use fixing nails and screws supplied by Decra, OTHERWISE the Decra guarantee is invalidated.

Decra roofing felt or breather membranes.

Soft soled safety shoes.

Safety helmet.

*Decra Power nails are designed for use with a Paslode IM350 frame nailer gun.

3. You Also Need

To cut the tiles and accessories you need;

Decra Tile Guillotine or alternatively a reciprocating saw or jigsaw (fitted with an appropriate Decra Cutting Blade).

i DO NOT USE angle grinders or disk cutting equipment.

To form edge details to the perimeters of the roof you need.

Decra Bender.

Decra Tile Bender Attachment (for bending the full length of a tile).

IMPORTANT - Operatives are reminded to take all due care when handling sharp edges and using tools.

4. Setting Out The Fascia Board At Eaves

The positioning of the fascia board at the eaves is crucial to the success of the installation

The fascia board must be set at the right height, set too low the tiles will dive, set too high the tiles will kick up at the wrong angle. The top edge of the fascia board should be set at the same height as the tile battens.

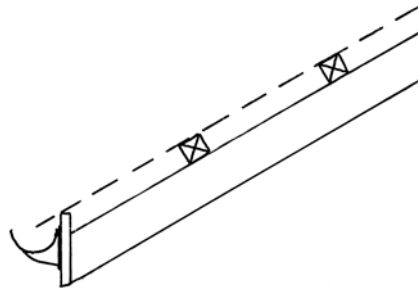

However if you are installing fascia mounted eave ventilators or Decra Eaves Guard the fascia board may need to be set lower (refer to the instructions supplied in the Decra Ventilation pack & Decra Eaves Guard pack).

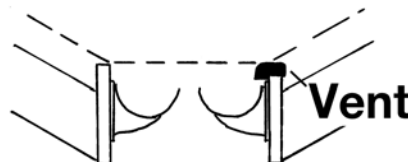

Unventilated

Ventilated

5. Battening

The most crucial factor in laying tiles is the accurate setting out of the tile battens, if you are not accurate then the tiles won't fit together properly.

Time spent taking extra care when battening is time saved when tiling.

Rafter Centres	Batten Size (recommended)
450mm	50mm x 38mm
600mm	50mm x 38mm
900mm	50mm x 50mm
1200mm	50mm x 50mm

6. Setting Out The Battens At Eaves

The positioning of the first batten at the eaves is crucial to the success of the installation.

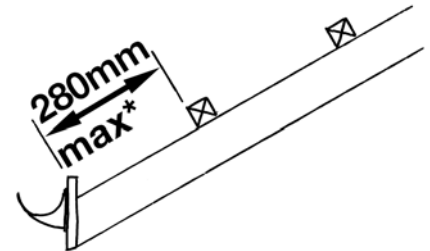

* The first tile batten should be placed in a position to suit the roof pitch and/or type of gutter, typically this is 280mm from the front edge of the fascia board to the front edge of the first tile batten.

However if you are installing fascia mounted eave ventilators refer to the instructions supplied in the Decra Ventilation pack.

7. Battening The Roof

Then fix the other battens working from the bottom of the rafter.

At 320mm spacings from front lower face of batten to front lower face of batten.

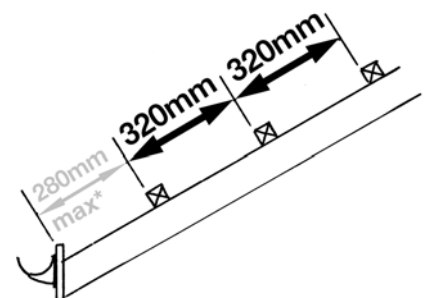

Care should be taken to be accurate when installing the battens. Time spent taking extra care when battening is time saved when tiling.

8. Decra Eaves Guards

Decra Eaves Guard is an eave protection system which is installed underneath the roofing underlay providing support for the underlay at eaves.

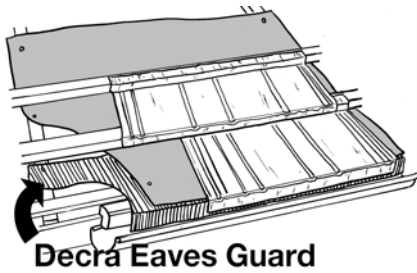

The installation procedure for the Decra Eave Guard varies according to roof pitch and rafter spacing.

If you are installing the Decra Eaves Guard refer to the instruction supplied in Decra Eaves Guard pack.

9. Setting Out Gables

Fix the barge boards in a position where they are level with the tops of the tile battens.

Underlay should turn up against the edge of bargeboard by 38mm.

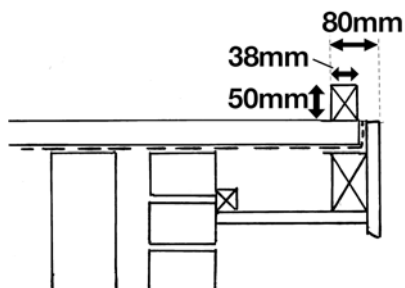

On top of the tile battens nail an additional 50mm x 38mm gable runner batten up the slope of the roof. This batten should be set 80mm in from the outer edge of the bargeboard (see drawing above).

10. Walking On The Tiles

When walking on the roof it is strongly recommended that installers should wear soft soled safety shoes to avoid any possible abrasion to the surface coating.

Your weight should be concentrated over the front edge of the tile, as this is the area supported by battens.

i If you have managed to dent a tile refer to the tips section in the back of this guide.

11. Start Laying The Tiles

Lay the tiles starting at the batten below the ridge and next to the gable

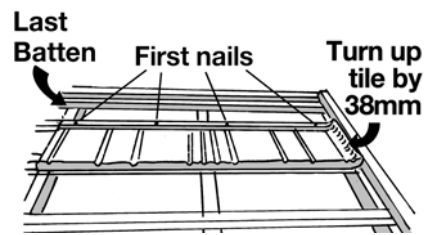

When putting your first nails in take care not to puncture the underlay below.

Q Why lay from the top?

A Although this is the opposite of traditional tiling practice, by laying from the top the tiles interlock tighter and it is actually quicker to lay the Decra tiles this way.

Cut the first row of tiles from the bargeboard into random widths so that the profile of the tile does not appear in the same vertical position. Form a 38mm upstand in the cut edge of the tile and abut the upstand edge against the gable runner batten (see setting out gables section).

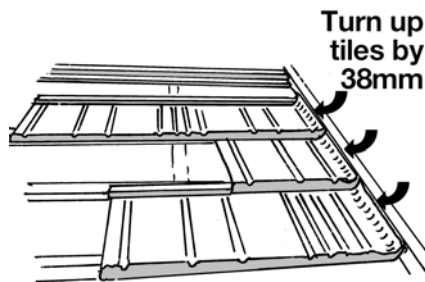

Q Do I lay the tiles straight Bond or staggered Bond?

A Stratos tiles should always be laid staggered bond ensuring that a repeat pattern does not appear in the side overlap down the roof slope. For best appearance lay the laps away from the principle line of site of the building.

Q How much side lap?

A

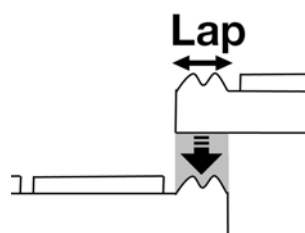

12. When You Have Laid Several Courses

When you have laid several courses (laying them one under the other, by lifting the nose of a tile and tucking the next tile under) start nailing with Decra nails, 4 per tile.

Nail tiles through the nose as shown in the sketches, leaving bottom course loose until more tiles are laid. One nailing point must be at lap of course below.

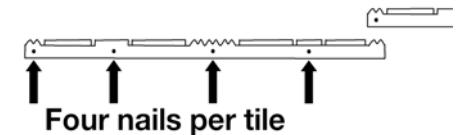

Tilt nail downwards for the best fit



i You must only use fixing nails and screws supplied by Decra, OTHERWISE the Decra guarantee is invalidated.

13. Nail The Eaves Course

Nail the eaves course at the high points of the tile surface into the top of fascia or eaves batten (if eaves ventilation is being fitted, see ventilation pack for nail positions).

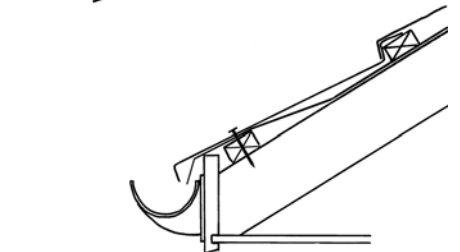
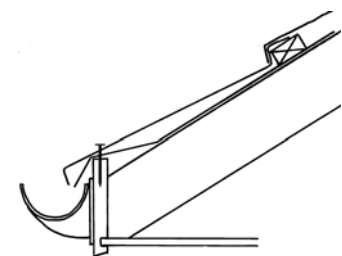
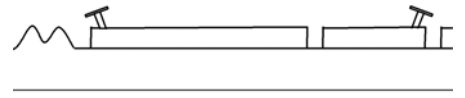

Use 4 nails per each tile.

After completion of roof cover these nail heads with Decra finishing kit.

14. Gables

Start off at the eaves by nailing a Decra Barge Cover Eave Closure into position (see image below). Fold lower half of front edge of barge cover back up and behind front lip of eaves tile (see grey shaded area on image below).

After completion of roof cover these nail heads with Decra finishing kit.

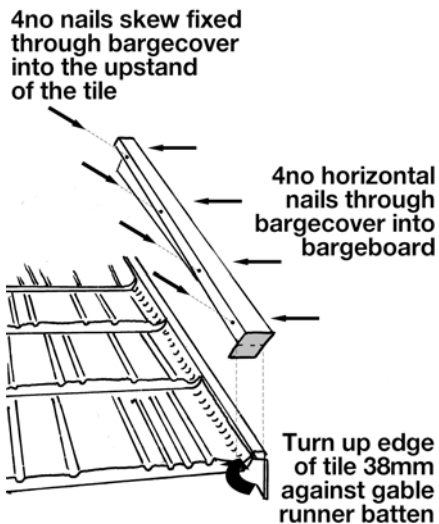

Nail remaining bargecovers into position using 4 nails skew fixed down the inner face of the bargecover into the upstand of the tile and 4 horizontally as before. Care should be taken to ensure bargecovers are correctly lapped.

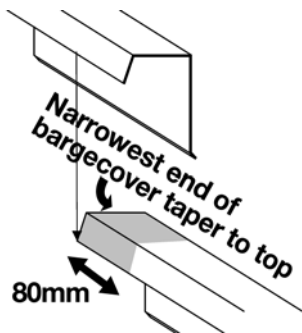

After completion of roof cover the bargecover nail heads with Decra finishing kit.

15. Ridge Course D Ridge

The correct way to install the top course of tiles and the ridge tiles is determined by whether you are trying to achieve an unventilated or ventilated ridge detail.



Universal ridge ventilator

16. Preparation Of The Top Course Of Tiles

When you have cut and bent the tile you may find there is some natural distortion in the tile and it may look like the tile won't fit. This is perfectly normal

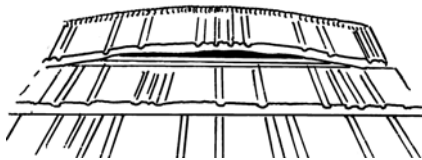

There is a standard procedure for removing any distortion. If this procedure is followed, installation is simple. If not followed it will be difficult to achieve a good fit.

Step 1: Do not try to squash the tile into position at this stage (wait until you have completed step 4).

Locate front corner of tile into the interlocking profile of tile below and nail this corner into position.

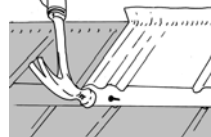

Step 2: Locate rear corner of tile into interlock of adjoining tile and nail this corner into position as appropriate.

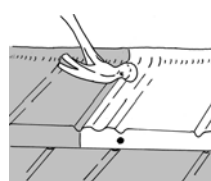

Step 3: Locate other front corner of tile into interlock of tile below and nail this corner into position.

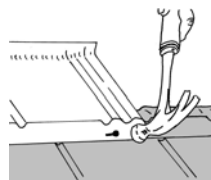

Step 4: locate remaining rear corner of tile into position and nail as appropriate.

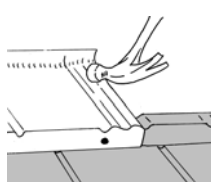

Step 5: Push front edge of tile into position and work your way into the middle nailing as you go.

17. Ridge Course Nailing & Lapping D Ridges

The ridge caps have a slight taper in their design. Place the wider end of the ridge over the narrower end of the ridge beneath creating an 80mm overlap.

Each ridge should be secured with 4 nails on each side of the ridge cap.

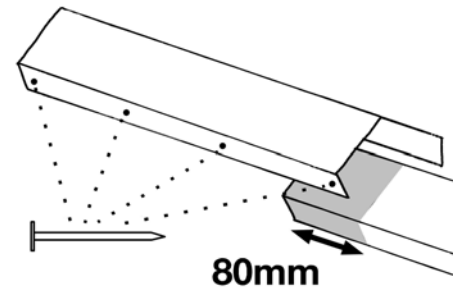

18. Ridge Course D Ridge (Unventilated)

Fit two tile battens either side of ridge. Fix additional 50mm x 38mm batten to suit D Ridge on top of rear of the two tile battens.

Lay top course of tiles with back turned up 38mm.

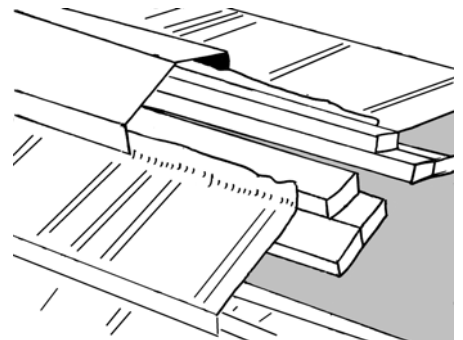

i For tips on cutting and bending tiles, see back of this guide.

19. Ridge Course D Ridge With Universal D Ridge Vent



Universal ridge ventilator

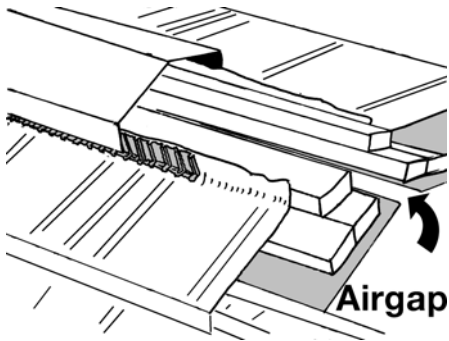

Cut underlay short of ridge line and fit two tiles battens either side of ridge, leaving a sufficient gap for ventilation.

Fix additional tile batten to suit ridge on top of rear of the two tile battens.

Lay top course of tiles with back turned up 38mm against top tile batten.

Place ridge cap into position over the top batten and the upstand edge of tile. Pull bottom edge of ridge cap away from the upstand edge of tiles and slip Universal 'D' ridge/hip ventilators into position on each side of the 'D' ridge cap. Ventilators should run continuously along each side of the ridge cap.

The ridge cap and ventilator to be nailed through the downturn of the ridge cap into the face of the batten, using four Decra fixing nails on each side.

i For tips on cutting and bending tiles, see back of this guide

20. D Ridge End Caps

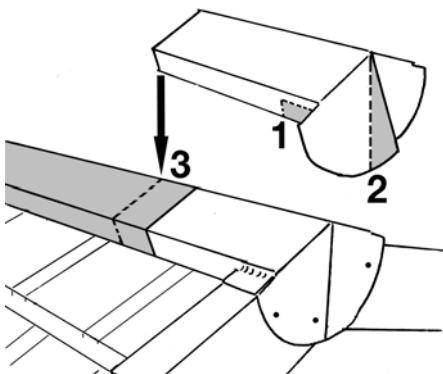

1. Snip and fold out flap to suit barge cover.

2. Trim edge of flap to create a vertical plumbline when fitted.

3. Install D Ridges over end of D Ridge End Cap ensuring good tight lap occurs. Then nail D Ridge End Cap into position (Fix vertical end of D Ridge End Cap first).

21. Mono-Pitch D Ridge

Mono-pitch ridge caps can be formed by adjusting the angles of Decra's standard D Ridge cap.

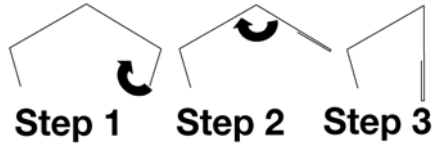

The procedure for installing the monopitch ridge is essentially the same as the detail for the ridges (please refer to ridge instruction shown earlier in this guide).

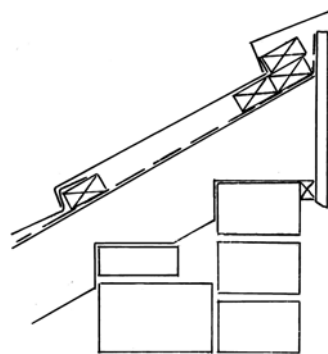

Unvented

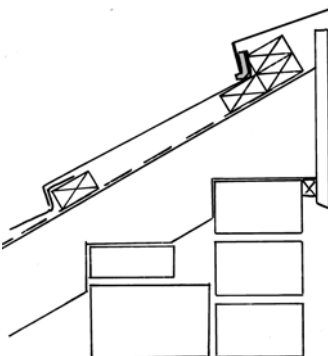

Vented using a Universal D Ridge Vent*

*When fitting the two tile battens at the top remember to leave a sufficient gap for ventilation.

* When fitting the D ridge ensure that a gap of at least 5mm is maintained between the underside of the ridge and the topmost batten.

i For tips on cutting and bending tiles, see back of this guide.

22. Top Edge Abutment

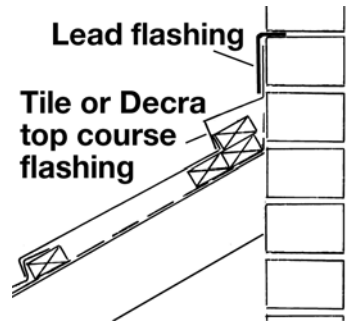

Unvented

Turn the tile (or a Decra Top Course flashing) and the roofing underlay 75mm up the abutment wall and cover over with a lead flashing.

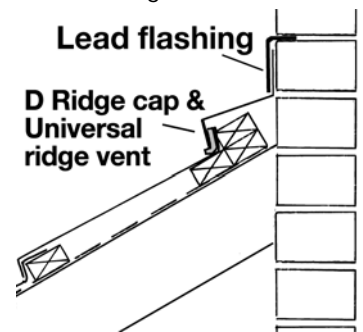

Vented with a Universal D Ridge Vent Filler

An appropriate top course flashing for use with Decra's Universal D ridge ventilator can be formed using a Decra Top Course flashing or alternatively by adjusting the angles of Decra's standard D Ridge cap. When fitting the top course flashing ensure that a gap of at least 5mm is maintained between the underside of the top course flashing and the topmost batten.

(When fitting the two tile battens at the top remember to leave a sufficient gap for ventilation)

i For tips on cutting and bending tiles, see back of this guide.

23. Side Edge Abutment

Turn the tile and roofing underlay 75mm up the abutment wall and cover over with a lead flashing

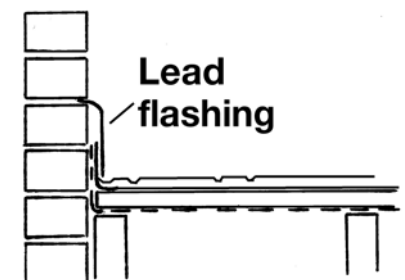

i For tips on cutting and bending tiles, see back of this guide.

24. Hips

Install tile battens to suit gauge of tiles, ensure that tile battens project to centre line of hip tree.

Install hip runner batten to each side of hip to suit width of hip cap component.

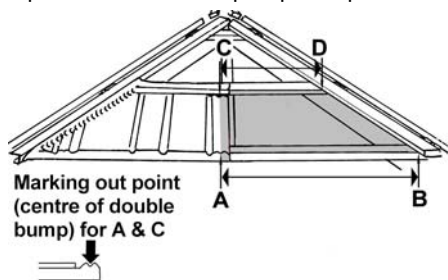

Step 1, Measuring for the Hip Tile

Measure from point (A) to (B), Measure from point (C) to (D), write down these measurements as these will be the set distances to make your bend at

Step 2, Marking Out Your Hip Tile

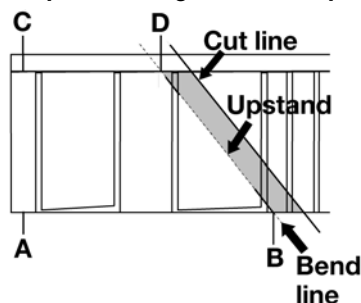

Markout the same measurement (A) to (B) & (C) to (D) on a tile. When transferring measurements to tile ensure measurement correspond with the position underlying tile batten.

Scribe a line from (B) to (D), this will be the bending point for your hip tile.

Scribe an additional cut line on to the tile to allow for a tile upstand at the hip. This upstand should be sufficient to cover the hip runner batten (any excess in the upturn can be dressed over the top of the hip batten).

Step 3, Cut and bend your hip tile

See tips on cutting and bending tiles at back of this guide

Step 4, Install ridge cap to hip

The methods for installing Decra D ridges with or without Universal D ridge ventilators is the same in principle as shown for the ridge detailing earlier in this guide.

NOTE: Pre-finished hip end closures are available for the foot of the hip.

25. Forming A Three Way Intersection At Hips

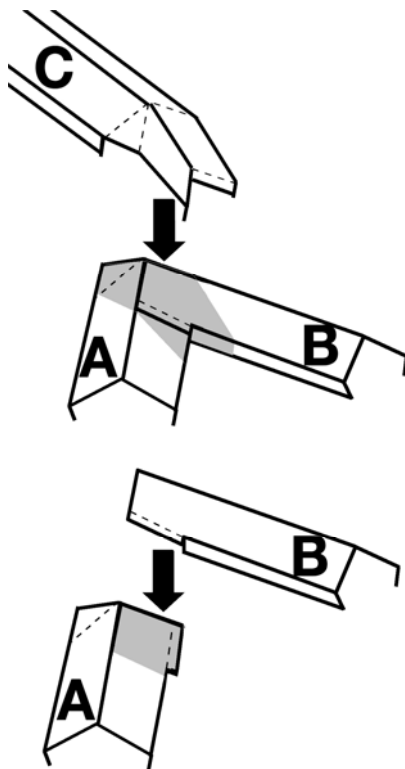

To form a three way intersection using D Ridges cut and fold tabs and flaps in ridge tiles as shown ridge sections A, B & C above. Install ridge section A followed by ridge section B then C on top. Nail ridge caps into position and touch up with Decra finishing kit.

26. Valleys

Lay valley boards flush with rafter level and install valley runner batten to each side of valley.

If needed install an additional packer batten, parallel to side of valley runner batten, so as to support sweep of tile batten.

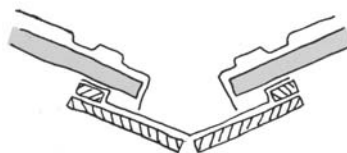

Install tile battens to suit gauge of tiles, ensure that tile battens sweep up and over valley runner batten. Cut battens to rake projecting over valley to 65mm short of centre line of valley.



For measuring, marking out, cutting and bending valley tiles follow the same procedure as the hips (refer to hip section). But form a downturn in the valley tile rather than an upstand.

NOTE: When forming a downturn in the tile take a measurement from top of leading edge of tile batten to valley surface and allow for tolerance in fit to avoid the downturned edge of the tile making any contact with valley surface.



For tips on cutting and bending tiles, see back of this guide

27. Creating An Infill Piece

At hips and valleys you will sometimes find that the tile you are about to cut is too small to provide sufficient coverage.

To solve this problem it is often useful to replace the last full tile (i.e the tile next to the tile you are about cut) with an infill piece of tile

The image below shows the variety of infill piece you can cut from a Stratos tile. Each infill piece has an interlocking channel to the left and the right of it which will interlock with other Stratos tiles.

For best appearance when fitting an infill piece lap the cut edge of the infill piece underneath the tile next to it.

